

GAMBAR DED

PERENCANAAN PASAR PARWASAL TIPE C - PONTIANAK

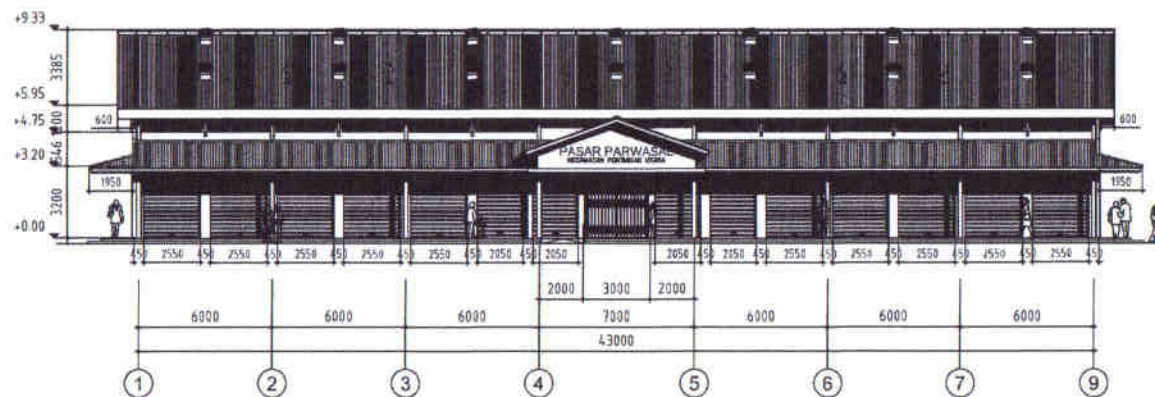

KONSULTAN PERENCANAAN

SIMBOL, NOTASI, KODE GAMBAR & MATERIAL FINISHING

NOTASI GAMBAR			SIMBOL ARSIRAN GAMBAR			SIMBOL DAN SPESIFIKASI MATERIAL		
NO	KODE/NOTASI	KETERANGAN	NO	SIMBOL	KETERANGAN			
1		KODE TAMPAK / VIEW 1 : NOMOR URUT TAMPAK A : NOMOR PETUNJUK HALAMAN	1		PASANGAN DINDING 1/2 BATA DENGAN ADUKAN 1 : 4	KODE DINDING : : DINDING FINISH CAT EXTERIOR WEATERSHIELD WARNA PUTIH MERK VINILEX ATAU SETARA : DINDING FINISH CAT INTERIOR WARNA PUTIH MERK VINILEX ATAU SETARA : DINDING FINISH KERAMIK 20x20 MERK ASIA TILE ATAU SETARA : DINDING BETON FINISH CAT EXTERIOR WEATERSHIELD WARNA PUTIH MERK VINILEX ATAU SETARA : DINDING BETON FINISH CAT INTERIOR WARNA PUTIH MERK VINILEX ATAU SETARA KODE LANTAI : LANTAI KERAMIK 20x20 WARNA PUTIH MERK ASIA TILE ATAU SETARA : LANTAI KERAMIK 20x20 WARNA CREAM MERK ASIA TILE ATAU SETARA : LANTAI KERAMIK 20x20 WARNA ABU-ABU JENIS ROCKTILE (KASAR) MERK ASIA TILE ATAU SETARA : RABAT BETON ALUR GARIS KASAR KODE KUSEN : ROLLING DOOR ALUMINIUM UKURAN 2.55x2.15 : ROLLING DOOR ALUMINIUM UKURAN 2.47x2.15 : ROLLING DOOR ALUMINIUM UKURAN 2.47x2.15 : BOUVEN MATERIAL BESI SIKU DAN KAWAT HARMONIKA UKURAN 2.70x1.00 : BOUVEN MATERIAL BESI SIKU DAN KAWAT HARMONIKA UKURAN 1.77x1.00 : BOUVEN KACA NAKO MATERIAL ALUMINIUM 3" DAN KACA NAKO UKURAN 2.70x1.00 : BOUVEN KACA NAKO MATERIAL ALUMINIUM 3" DAN KACA NAKO UKURAN 1.77x1.00 : KUSEN DAN DAUN PINTU JENDELA KACA ALUMINIUM 3" MERK ALEXINDO/INDAL ATAU SETARA : KUSEN PINTU ALUMINIUM 3" MERK ALEXINDO/INDAL ATAU SETARA JENDELA KACA NAKO : KUSEN PINTU TOILET MATERIAL ALUMINIUM 3" MERK ALEXINDO/INDAL : KUSEN JENDELA KACA NAKO MATERIAL ALUMINIUM 3" MERK ALEXINDO/INDAL : KUSEN DAN DAUN PINTU KACA MATERIAL ALUMINIUM 3" MERK ALEXINDO/INDAL : KUSEN DAN DAUN PINTU BESI : FOLDING GATE / PINTU HARMONIKA : FOLDING GATE / PINTU HARMONIKA		
2		KODE POTONGAN / SECTION 1 : NOMOR URUT POTONGAN A : NOMOR PETUNJUK HALAMAN	2		PASANGAN DINDING 1/2 BATA TRASRAM DENGAN ADUKAN 1 : 2			
3		KODE DETAIL / BLOWUP 1 : NOMOR URUT DETAIL A : NOMOR PETUNJUK HALAMAN	3		POTONGAN BETON			
4		KODE AS / AXIS X : GARIS SUMBU KOORDINAT X Y : GARIS SUMBU KOORDINAT Y	4		PASIR URUG			
5		NOTASI DIMENSI X : MENUNJUKAN DATA UKURAN PADA DIMENSI	5		POTONGAN RABAT			
6		NOTASI KETERANGAN POSISI PANAH MENUNJUKAN BIDANG YANG DIMAKSUD DALAM TEKS KETERANGAN	6		MUKA TANAH EKSTINGSI			
7		KODE ELEVASI AKHIR F.F.E. : FLOOR FINSH ELEVATION (UNTUK ELEVASI AKHIR) ±0.00 : PETUNJUK ELEVASI	7		TANAH URUG			
8		KODE ELEVASI STRUKTUR F.F.E. : SLAB STRUCTURE ELEVATION (UNTUK ELEVASI STRUKTUR/TANPA FINISHING) ±0.00 : PETUNJUK ELEVASI	8		TAMPAK KACA			
9		NOTASI PERBEDAAN ELEVASI MENUNJUKAN ADANYA PERBEDAAN ELEVASI PADA GARIS LANTAI DI BAMBANG DENAH X : MENUNJUKAN DATA UKURAN PERBEDAAN ELEVASI	9		POTONGAN ADUKAN ATAU SPESI			
10		NOTASI ELEVASI PLAFOND X : MENUNJUKAN DATA UKURAN PADA ELEVASI PLAFOND	NOTASI MEKANIKAL ELEKTRIKAL DAN PLUMBING					
11		NOTASI ELEVASI KETINGGIAN X : MENUNJUKAN KETERANGAN UKURAN KETINGGIAN BIDANG	NO	SIMBOL	KETERANGAN			
12		KODE CENTER LINE GARIS TERSEBUT MENUNJUKAN POSISI TEPAT PADA TENGAH-TENGAH BIDANG YANG SIMETRIS	1		PANEL MCP/SDP			
13		KODE SIRKULASI UDARA MENUNJUKAN POSISI JENDELA ATAU BUKAAN UDARA YANG TERPOTONG	2		METERAN LISTRIK PADA KIOS			
14		NOTASI ALIRAN AIR ARAH PANAH MENUNJUKAN ARAH ALIRAN AIR	3		MCB (MAIN CIRCUIT BREAKER) PADA MEJA LOS/LAPAK			
15		NOTASI UKURAN DAN JARAK BESI D : DIAMETER UNTUK BESI ULIR (mm) Ø : DIAMETER UNTUK BESI POLOS (mm) X : UKURAN DIAMETER BESI (mm) Y : UKURAN JARAK AS ANTAR BESI (mm)	4		KABEL TRAY			
16		NOTASI ACUAN PEMASANGAN KERAMIK KOTAK SILANG MENUNJUKAN LETAK ACUAN PEMASANGAN KERAMIK ARAH PANAH MENUNJUKAN ARAH PEMASANGAN KERAMIK	5		SAKLAR TUNGGAL			
			6		SAKLAR GANDA			
			7		STOP KONTAK			
			8		LAMPU TL 2X36 WATT			
			9		LAMPU TL 2X36 WATT EMERGENCY (INCLUDE BATERAI)			
			10		DOWN LIGHT 18 WATT			
			11		JALUR KABEL TIDAK BERHUBUNGAN			
			12		JALUR KABEL			
			13		PIPA TERPOTONG			
			14		NOTASI TITIK/LETAK KRAN			
			15		JALUR PIPA AIR BERSIH Ø : DIMENSI Y" : UKURAN DIMENSI PIPA (inch)			
			16		JALUR PIPA AIR KOTOR Ø : DIMENSI X" : UKURAN DIMENSI PIPA (inch) > : MENUNJUKAN ARAH ALIRAN AIR			
			17	WS : WASHTAPEL UR : URINAL FD : FLOOR DRAIN CL : CLOSET	KR : KRAN GS : GREASE TRAP CO : CLEAN OUT			

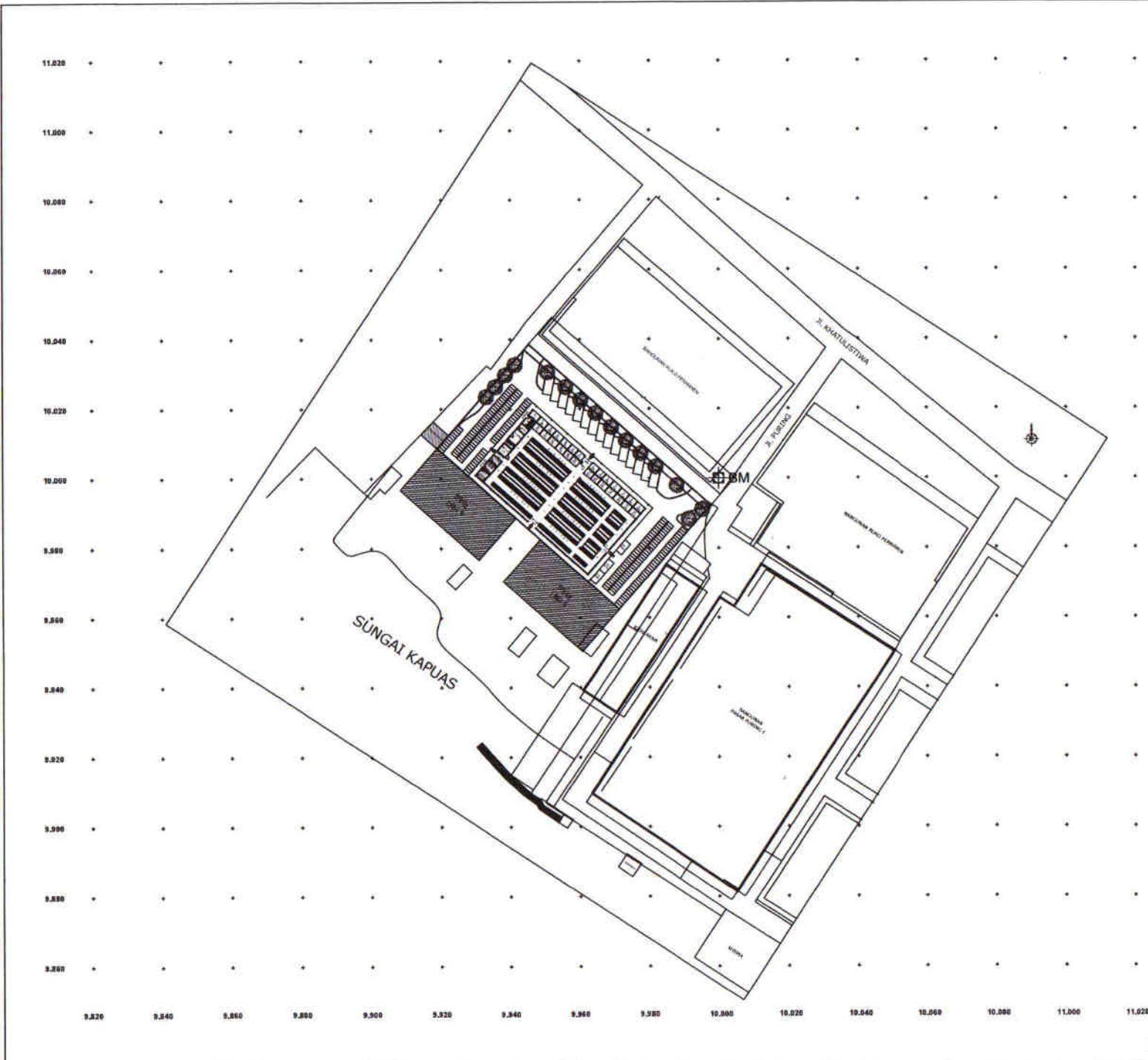

SITUASI
SKALA 1:100

KETERANGAN

Daftar Simbol
Key Plan

NO	REVISI	PARAF		
		R1	R2	R3

Catatan



Mengetahui
KEPALA BUREAU KOPERASI, USAHA MIKRO DAN PERDAGANGAN EKSTRA-PONTIANAK

KELOMPOK USAHA MIKRO DAN PERDAGANGAN
KOPERA USAHA MIKRO DAN PERDAGANGAN
PONTIANAK

WAKILAH MANAJEMEN
YUKA FILAR KREASI, PT
Engineering & Consulting Company

TIM TEKNIK		
INSPEKSI	LOKES MURNIDAR, ST, MT	
STRUKTUR	MERHAWATI FAR, ST	
MSE	BHIMBA DAVID, ST	

Proyek
Project
**PERENCANAAN PASAR PARSAWAL
TIPE C - PONTIANAK**

Nama Simbol

Shilo	No. Simbol	No. Proyek

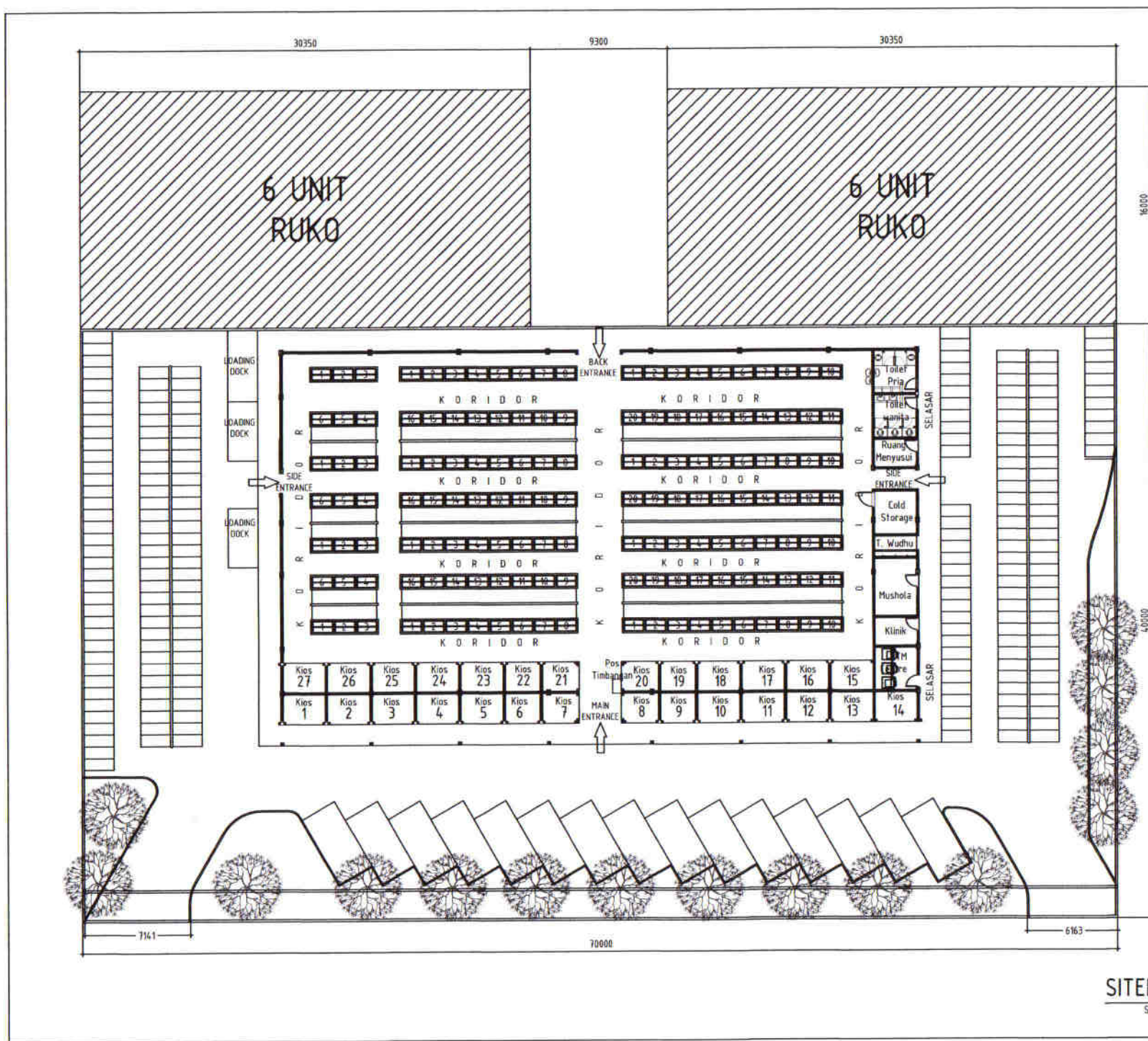

SITEPLAN
SKALA 1:250

KETERANGAN

Detail Kios, Kios Plan

NO	REVISI	PARAF		
		RI	R2	R3

Detail

Logo: KEMENTERIAN PERDAGANGAN REPUBLIK INDONESIA
MINISTRY OF TRADE
Jl. Cikini No. 104, Jakarta Pusat, 10132 Indonesia

Stamp: KEMENTERIAN PERDAGANGAN DAN KOPERASI
DINAS KOPERASI, USA MIKRO DAN PERDAGANGAN
KORPORASI PONTIANAK (KOPERSIPONT)

Stamp: BACHMUSUBANTO BI, MSi
KORPORASI PONTIANAK

Stamp: TIARA PILAR KREASI, PT
Jl. ...

TIM TEKNIK

ARHITEK	LOMBE WILANDARI SE, MT	
STRUKTUR	MUHAMMAD FAIZ SE	
MSE	WISNU DAHLI ST	

Project: **PERENCANAAN PASAR PARSAWAL TIPE C - PONTIANAK**

Detail

Detail	No. Gambar	No. Prosent

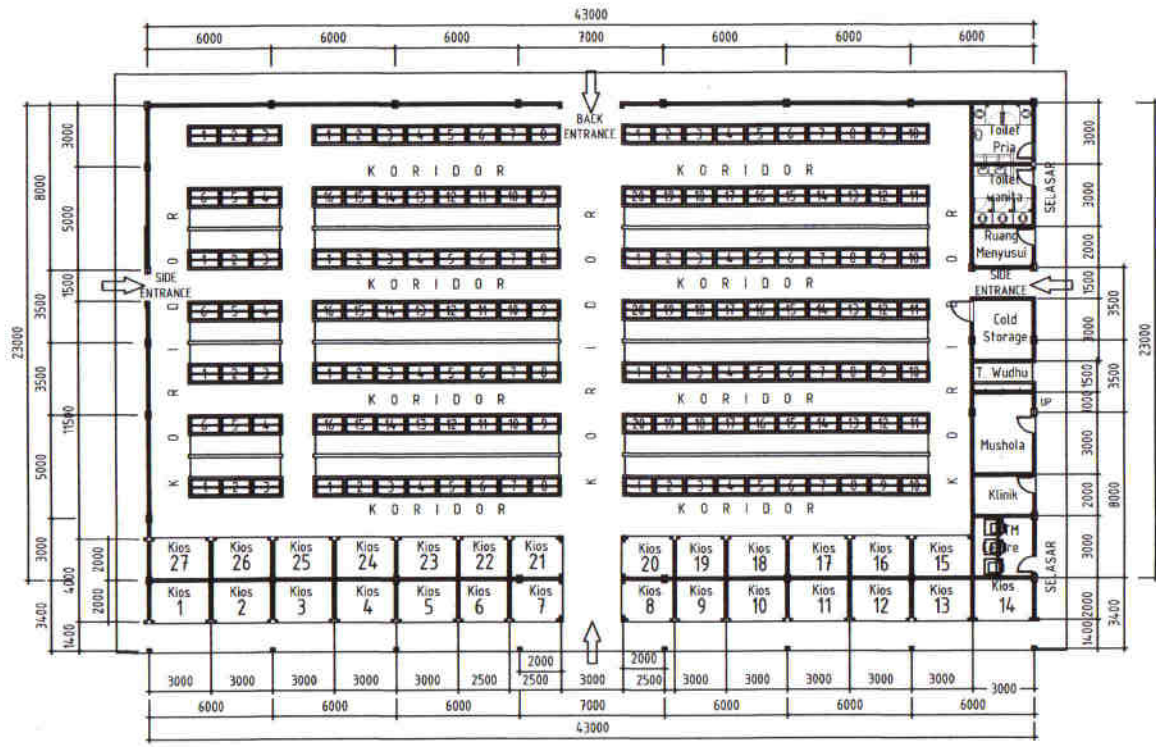

DENAH LANTAI 1
SKALA 1:250

KETERANGAN

Denah Lantai
Key Plan

NO	REVISI	PARAF		
		RI	R2	R3

Daftar



Mengesah

KOPERASI DAN KOPERASI USHAH MIKRO DAN PERDAGANGAN KOTA PONTIANAK

DNAS
KOPERASI MIKRO DAN PERDAGANGAN

Mengesah

PELAKSI PERENCANAAN (PROK)

MICHAEL SUPRIATNO, S.T., M.Eng.
MANAJER TEKNOLOGI

MENGUKUHI GAMBAR

TIARA PILAR KREASI, PT
Jl. ...

TIM TEKNIK

AMIRIK	LORRE WILANDARI, S.T., M.Eng.	
STRUKTUR	MUHAMMAD FAZ, S.T.	
MEK	BRIHM ZAKI, S.T.	

Proyek
Perencanaan PASAR PASAWAL
TIPE C - PONTIANAK

Nama Gambar

No.	No. Gambar	No. Proyek

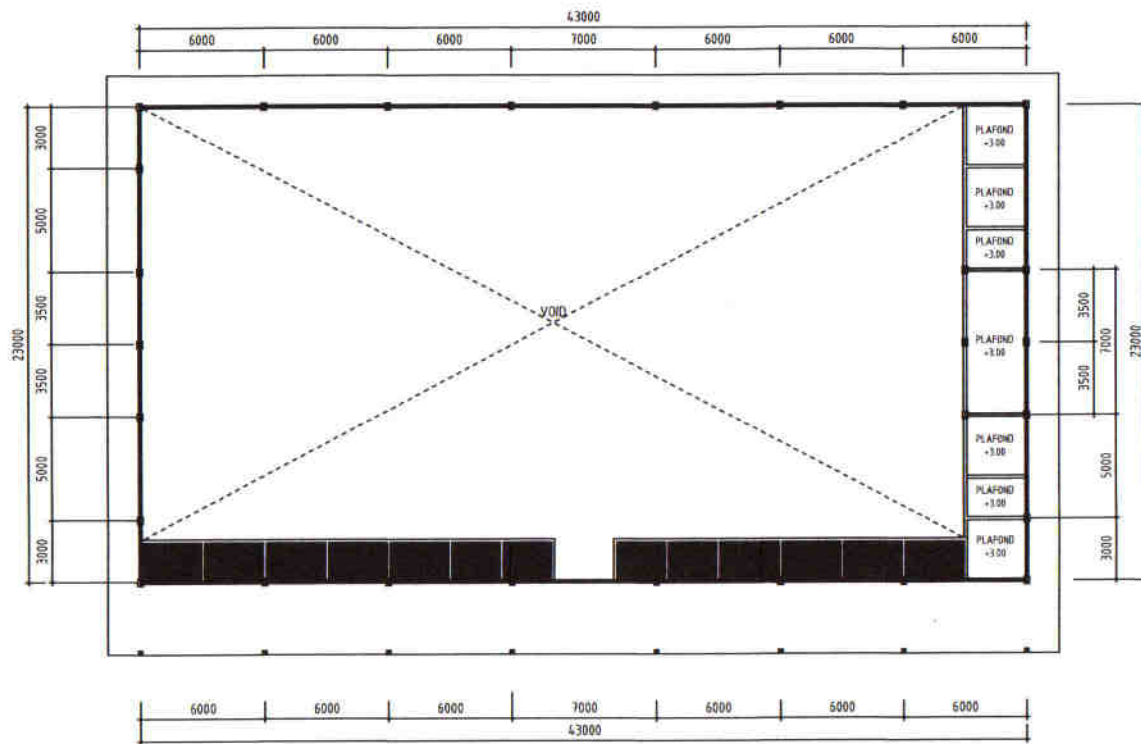

DENAH LANTAI 2
SKALA 1:250

KETERANGAN

Denah Lantai
Key Plan

NO	REVISI	PARAF		
		RI	R2	R3

Contoh:



Mencantumkan
KEPALA DINAS KOPERASI, USAHA MIKRO DAN PERDAGANGAN
KOTA PONTIANAK



Mencantumkan
PEMERINTAH KABUPATEN PONTIANAK



TIM TEKNIK		
ARSITEK	LOJISE WALANDAR, ST, MT	
STRUKTUR	MUHAMMAD FAIZ, ST	
MEK	BIRAHIM SULAI, ST	

Proyek
Perencanaan PASAR PARSAWAL
Tipe C - PONTIANAK

Nama Gambar:		
No.	No. Gambar	No. Proyek

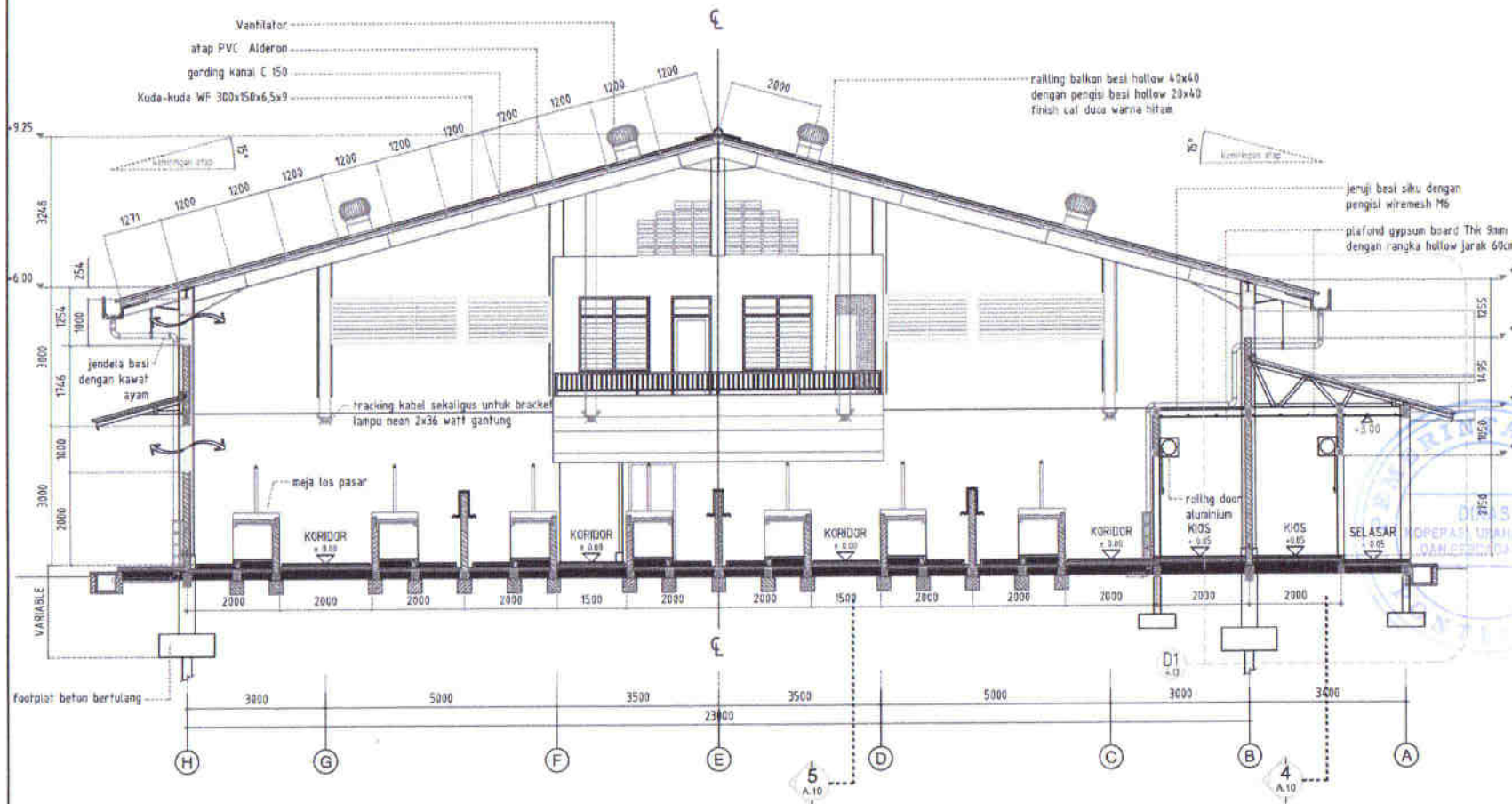

POTONGAN 1 (SECTION 1)
SKALA 1:100

KETERANGAN

Daerah Kerja
Key Plan

NO	REVISI	PARAF		
		RI	RE	RS

Catatan



Manajer Teknik
KIPRA DAIRY HOPKINS, UMBU SERING DAN PERDAGANGAN
KOTA SUKSESARAH
Handwritten signature
JURUSAN TEKNIK SIPIL
UNIVERSITAS BINA SARASWATI

Manajer Proyek
KIPRA DAIRY HOPKINS, UMBU SERING DAN PERDAGANGAN
KOTA SUKSESARAH
Handwritten signature
MANAJER PROJEK KIPRA DAIRY HOPKINS, UMBU SERING DAN PERDAGANGAN
KOTA SUKSESARAH

KONSULTAN GAMBAR
TIARA PEAR KREASI PT
Manajemen & Engineering Consultant
Jl. Raya Cendekia No. 100, Cendekia, Tangerang Selatan, Banten 15138

TIM TEKNIK
INSYENIR LOGIS RULANDI ST, MT
STRUKTUR MEMPUSAT FAD ST
MSE IMANINGZILLA ST

Daerah Kerja
Project
KIPRA DAIRY HOPKINS, UMBU SERING DAN PERDAGANGAN
KOTA SUKSESARAH

Nama Gambar
POTONGAN 1

Skala	No. Gambar	No. Dampak
1:100		A.03

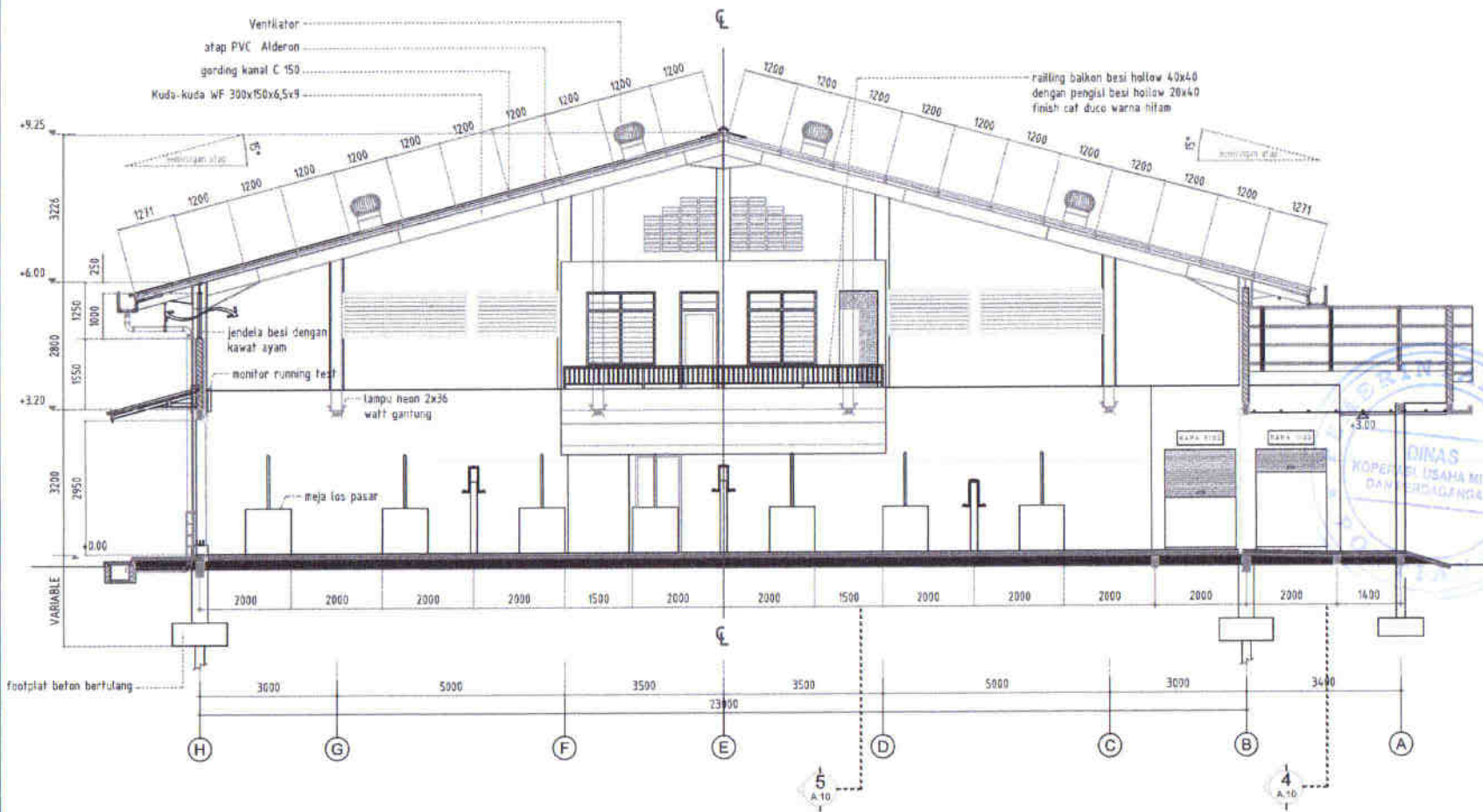

POTONGAN 2 (SECTION 2)

SKALA 1:100

KETERANGAN

Densit, Kursi, Any. Plan			
NO	REVISI	PARAF	
		RI	RII

Catatan



Mengarahkan
 Kepala Dinas
 KEMENTERIAN PERDAGANGAN REPUBLIK INDONESIA
 JALAN PINK, 12110 Jakarta

Mengarahkan
 Kepala Dinas
 KEMENTERIAN PERDAGANGAN REPUBLIK INDONESIA
 JALAN PINK, 12110 Jakarta

KONSULTAN JAWABAN
TIARA PILAR KREASI PT
 Management & Engineering Consultant
 Jl. ...

DESAIN
 MENTERI: LINDA SILAWATI, ST, MT
 STRUKTUR: MURMURATIAR ST
 MEE: BIRAHIM DALI ST

Proyek
 ...

Nama Gambar:
 POTONGAN 2

Skala	No. Gambar	No. Cetak
1:100		A.08

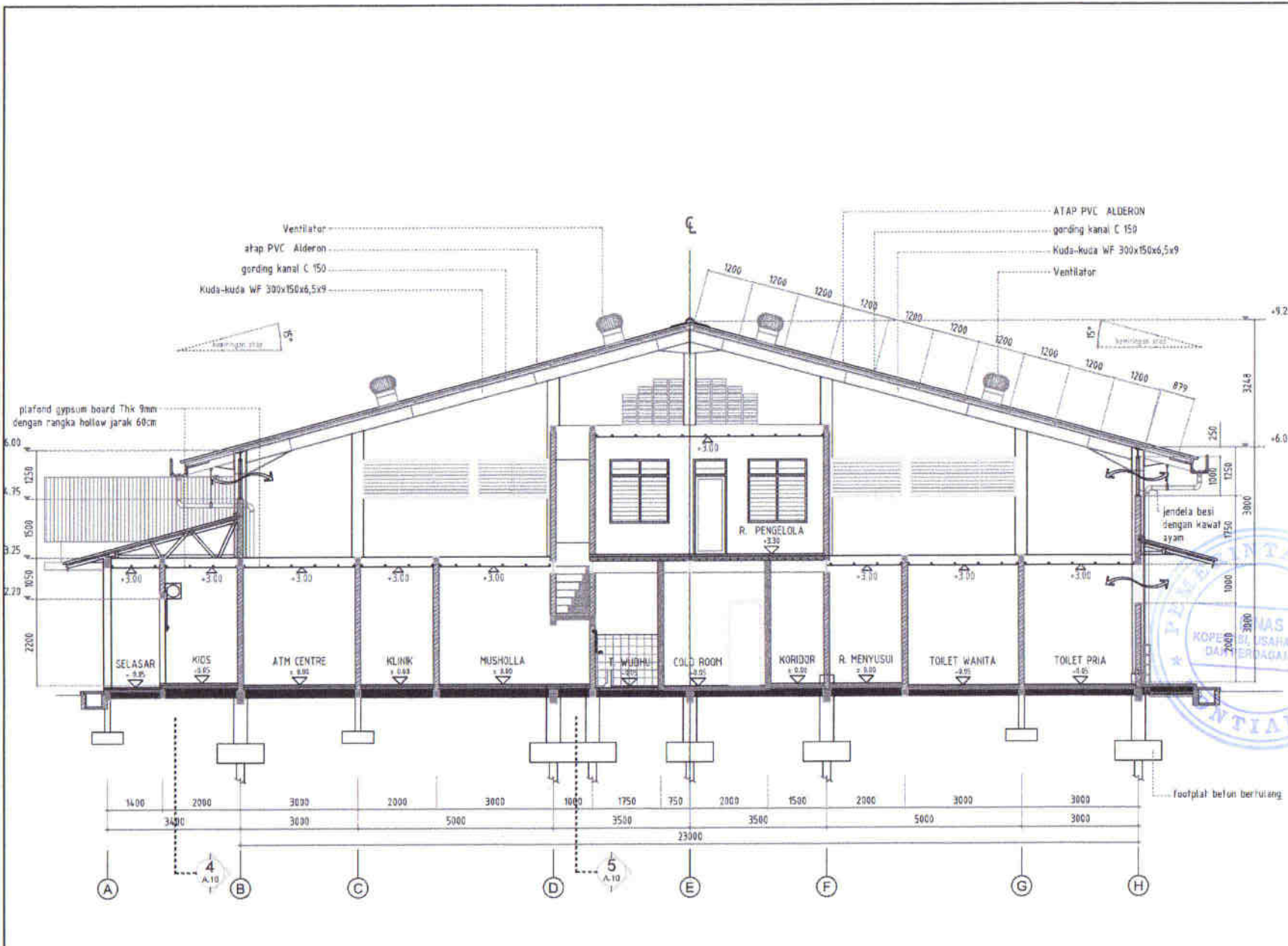

POTONGAN 3 (SECTION 3)
SKALA 1:100

KETERANGAN

Daftar Riwayat
Key Plan

NO	REVISI	PARAF
		R1 R2 R3

Catatan



Mengesah
NELLA DINDA KURNIA, UJIAN AKHIR DAN PENYUSUNAN KOTA PEKANTEN

Mentor
PROJEK PERKAWANAN KONTRAK PERKAWANAN

KONSULTAN GMBM
TIARA PILAR KREASI, PT
Manajemen & Engineering Consultant

TEK. TANDA

ARITIK	USANG SULANDI, ST, MT
STRUKTUR	ACHMAD FIKRI ST
MEE	DIYAH NITAH ST

Daftar
Project

Nama Gambar
POTONGAN 3

Skala	No. Gambar	No. Proyek
1:100		A.09

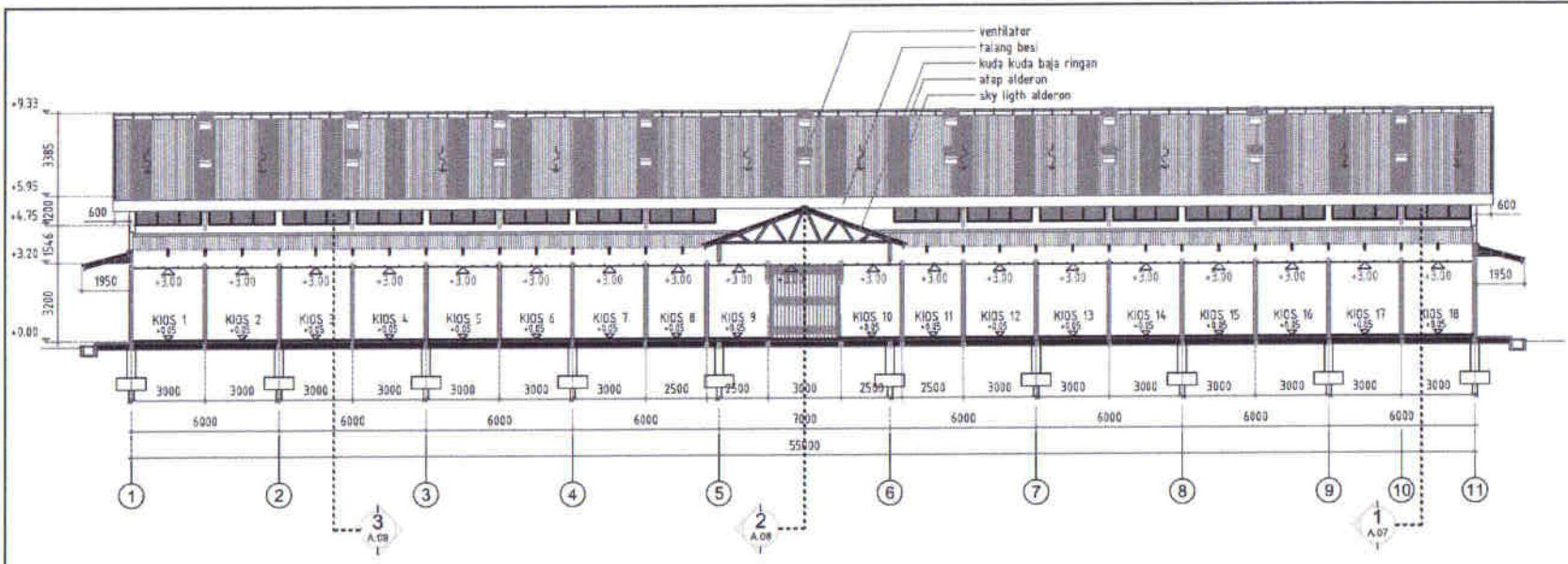

POTONGAN 4 (SECTION 4)

SKALA 1:200

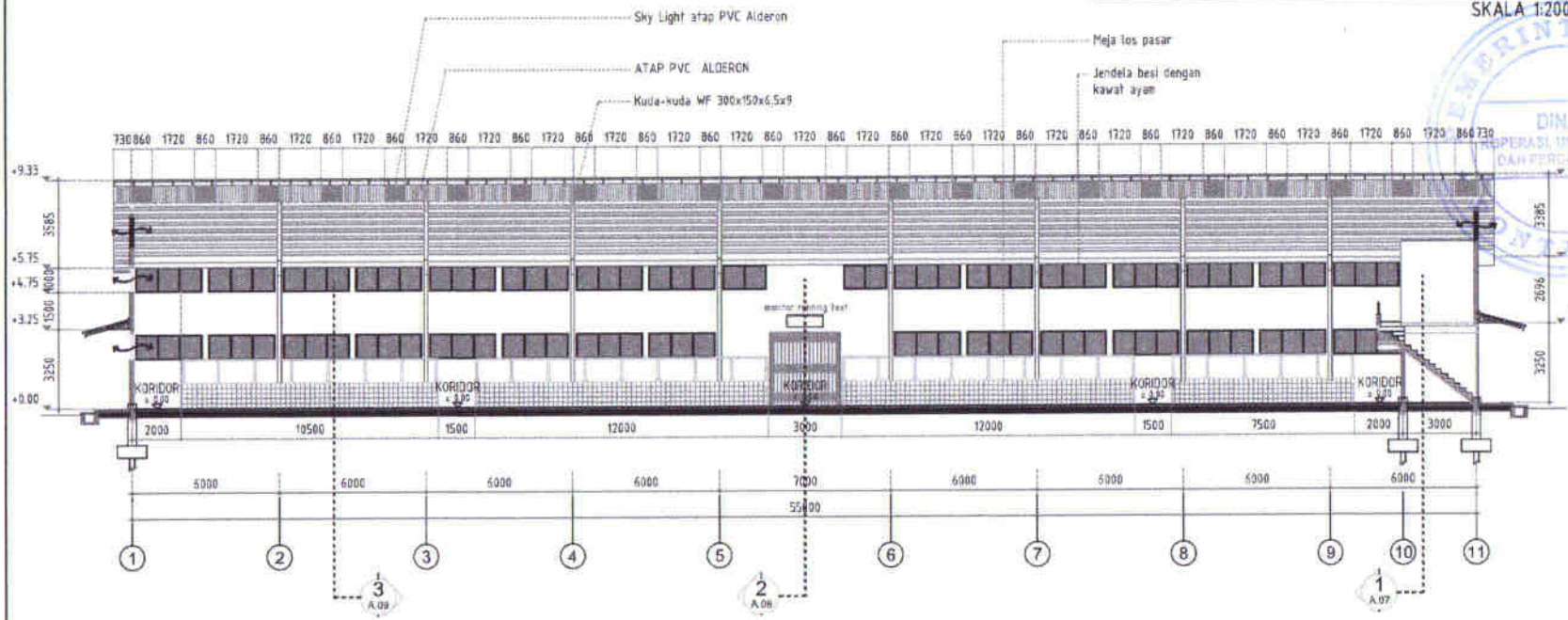

POTONGAN 5 (SECTION 5)

SKALA 1:200

KETERANGAN

Denah Kumpul
Key Plan

NO	REVISI	PARAF		
		R1	R2	R3

Catatan



Mengarahkan
KEPALA DINAS OPERASI USAHA MOTODOR PERDAGANGAN
DINAS PERDAGANGAN, PERUSAHAAN MOTODOR DAN PERDAGANGAN

Membantu
PELAKSANAAN PERUSAHAAN MOTODOR PERUSAHAAN
DINAS PERDAGANGAN, PERUSAHAAN MOTODOR DAN PERDAGANGAN

KONSULTAN DGN/GWI
TIARA PILAR BIRANI, PT
Structural & Engineering Consultant

DIR. TEKNIK
ARQUIT. LOUIS HILGARDI ST. MT

STRUKTUR. MAHMUD FAIZ ST
MEK. BIKRYAN DAULI ST

Proyek
Profil

Nama Gambar
POTONGAN 4/5

Skala	No. Gambar	No. Profil
1:200		A 10

KETERANGAN

Darah Jarak Key Plan			
NO	REVISI	PARAF	
		RI	RS
Catatan			
 <p>KEMENTERIAN REPUBLIK INDONESIA MINISTRY OF TRADE REPUBLIC OF INDONESIA</p>			
Managemen MENYALURKAN PERENCANAAN USAHA RAKYAT DAN PERENCANAAN PETA KAWASAN  <p>TITA HESTIANA SINERGI USAHA RAKYAT DIPERKOTAKAN</p>			
Managemen PELAKSI PUBLIK AT KOMUNITAS (PPK)  <p>RIZKI NURFITRIYATI, S.Pi. SARANGGI SURVIVATOR, S.Pi. DIPERKOTAKAN</p>			
KONSULTAN GAMBAR  <p>TIARA PILAR KREASI PT Management & Engineering Consultant Jl. Banteng No. 115, Kawasan Industri Cikarang, Kabupaten Cikarang Barat, Jawa Barat 40132</p>			
TEN TERIMA BOSTER LIPSE BILANDAN, ST. NT STRUKTUR MOHAMMAD FRED ST SITE BIRIHAN DUA ST 			
Proyek Project RENCANA LAYANAN PASAR RAKYAT ST. 1 - 001/2024/001			
Nama Gambar TAMPAK A&C			
Skala	No. Gambar	No. Proyek	
1:200		A.05	

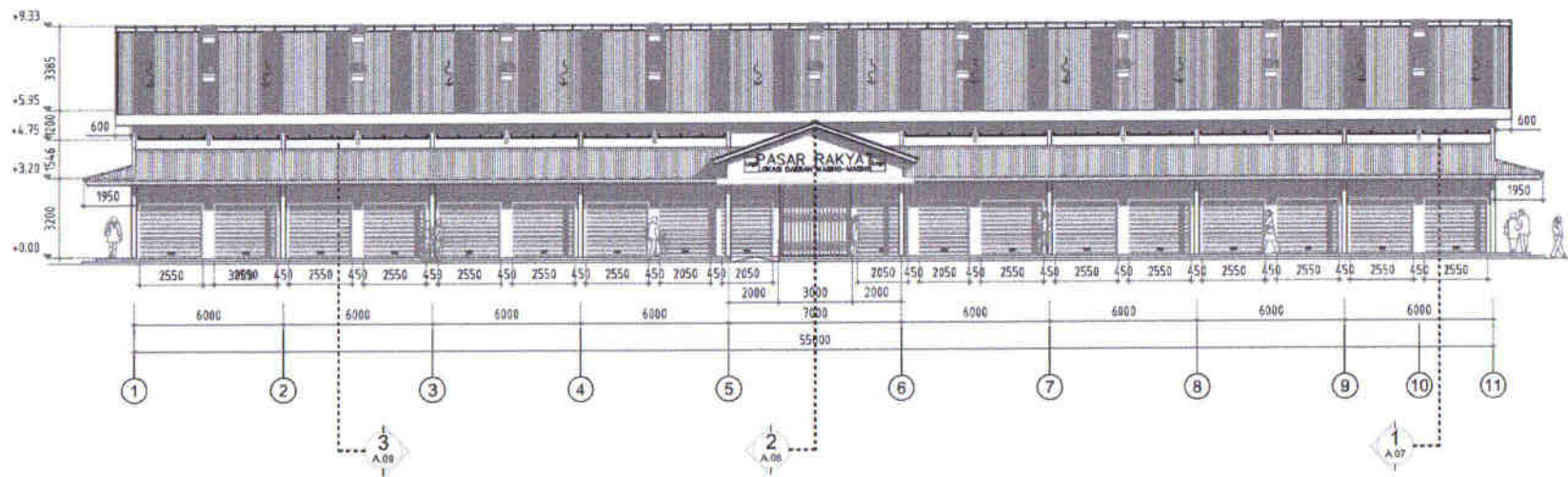

TAMPAK DEPAN (VIEW A)

SKALA 1:200

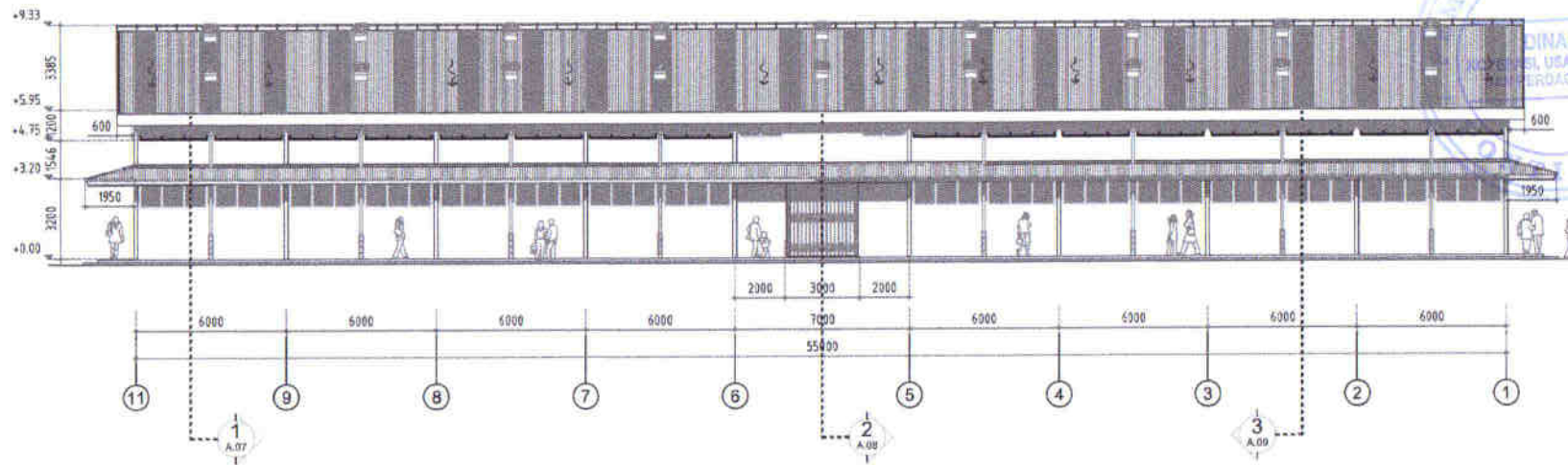

TAMPAK BELAKANG (VIEW C)

SKALA 1:200

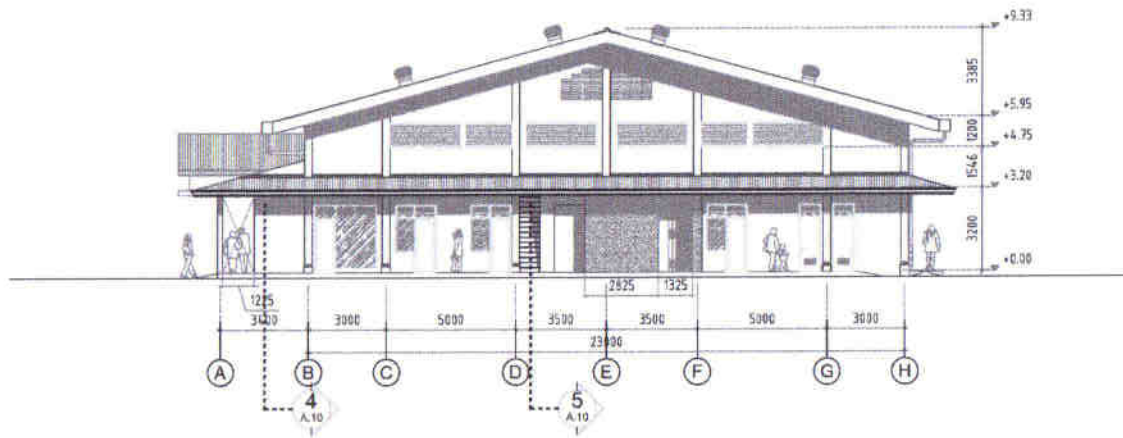

TAMPAK KANAN (VIEW B)

SKALA 1:200

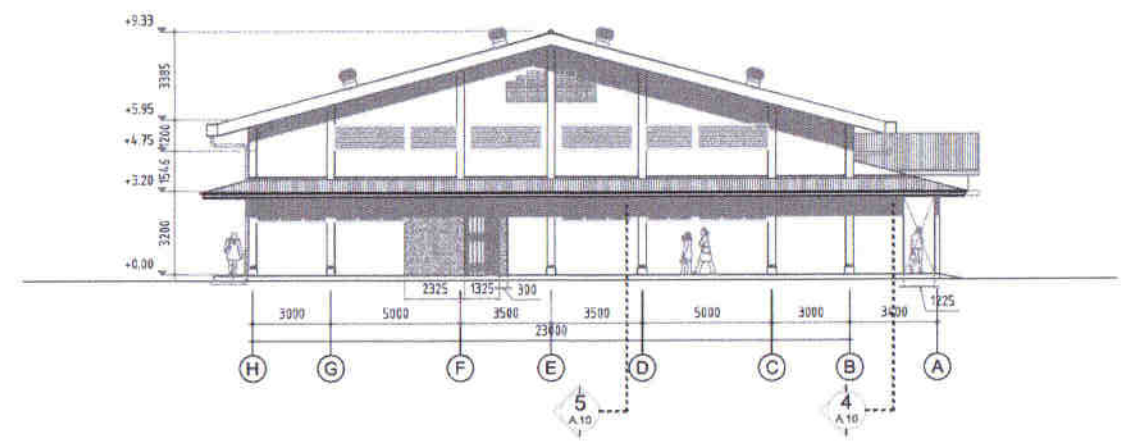

TAMPAK KIRI (VIEW D)

SKALA 1:200

KETERANGAN

Detail, Jend.,
Key Plan

NO	REVISI	PARAF		
		R1	R2	R3

Catatan



Manajer Umum

KEPILYANTAN KOPERASI, USAHA NIAGA DAN PERDAGANGAN
ZONA PONTIANAK

[Signature]
DINAS KOPERASI, USAHA NIAGA DAN PERDAGANGAN



Manajer Teknik

TIMBUL PERAKAT KORTEREN OFFICE

[Signature]
KORPORASI KOPERASI, USAHA NIAGA DAN PERDAGANGAN

KONSULTAN GAMBAR

TIARA PILAR KREASI, PT
Management & Engineering Consultant
Jl. Sekeloa Selatan 1 No. 11, Jakarta Selatan

TIM TEKNIS

NORTH	LOUIS BILANDRI, ST, MT	<i>[Signature]</i>
STRUKTUR	MURMANGI, PRC, ST	<i>[Signature]</i>
MEK	MURWELAN, ST	<i>[Signature]</i>

Project
KORPORASI KOPERASI, USAHA NIAGA DAN PERDAGANGAN
ZONA PONTIANAK

Nama Gambar

TAMPAK B&D

Skala	No. Gambar	No. Elemen
1:200		A.06

KETERANGAN

Denah Kusen
Rajut Plan

NO	REVISI	PABAT		
		R1	R2	R3

Catatan



Manajemen
SEKELUAS KOTA PONTIANAK, USAHA MIPRO DAN PERDAGANGAN KOTA PONTIANAK

[Signature]
JALAN R.F.3.9
PONTIANAK

Manajemen
PELAKSANAAN KONSTRUKSI BANGUNAN

[Signature]
BANGUNAN KONSTRUKSI BANGUNAN

KONSULTAN GANESHA
TIARA PILAR KREASI, PT
Desain, Gambar & Konstruksi Bangunan

TIM TEKNIK

WISATA: LULUS MAHASISWA, ST. WI

STRUKTUR: MAHASISWA, ST. WI

TAG: BANGUNAN, ST. WI

Disusun
Project

Nama Gambar

DENAH PONDASI

Skala: No. Gambar No. Proyek

1:250 & 1:20

S.01

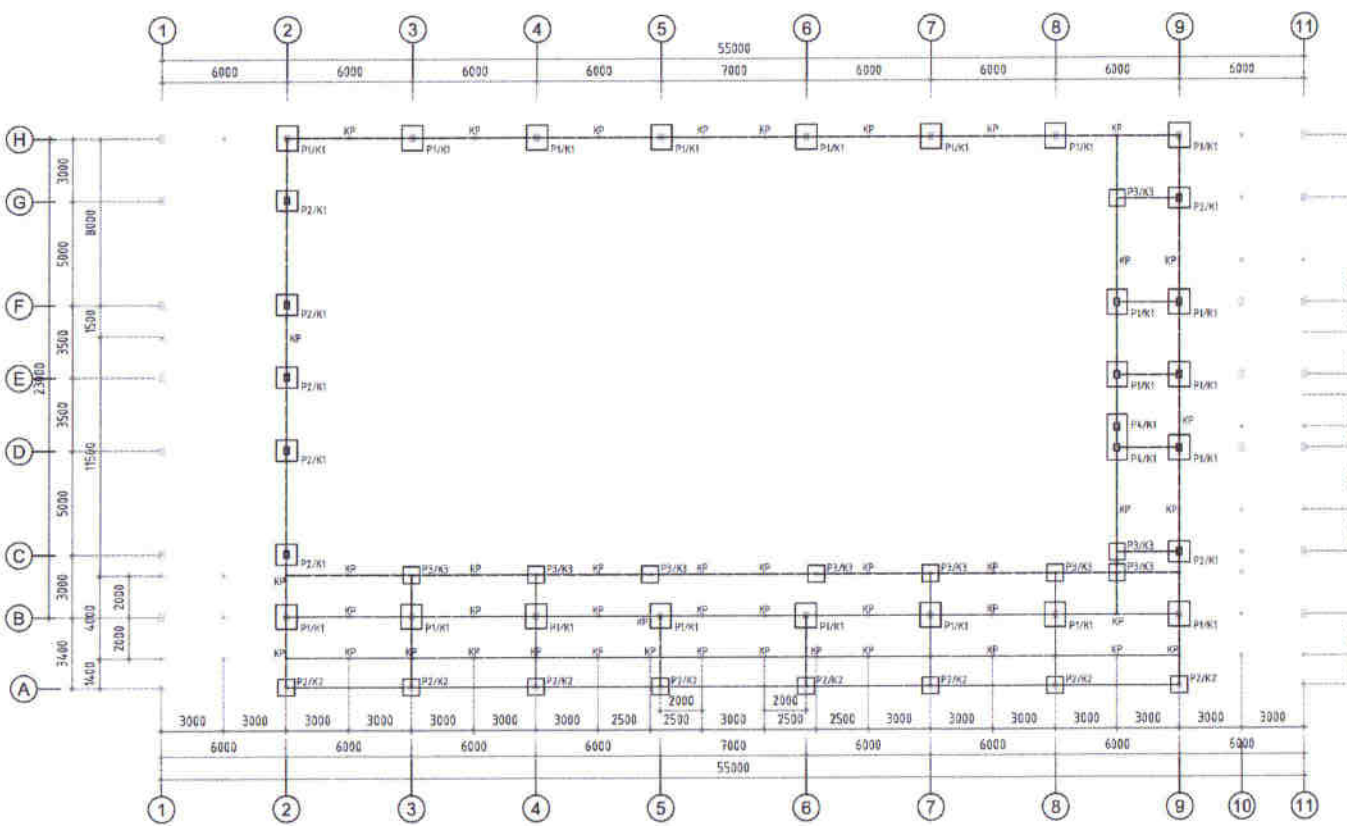

DENAH PONDASI
SKALA 1:250

DETAIL KOLOM

DETAIL SLOOF

TYPE	kolom 1 (K1)	kolom 2 (K2)	kolom 3 (K3)	kolom praktis (KP)
Skala 1:20				
Dimensi (mm)	250x350	180x180	130x130	130x130
Tulangan	12 D16	4 Ø12	4 Ø12	4 Ø10
Beugel	Ø8-100	Ø6-100	Ø6-100	Ø6-150
selimut beton	30mm	20mm	20mm	20mm
kuualitas beton	K300	K250	K250	K200
kuualitas besi	-	-	-	-

TYPE	Sloof 1 (S1)	Sloof 2 (S2)	Sloof 3 (S3)
Skala 1:20			
Dimensi (mm)	200x350	150x250	130x180
Tulangan atas	3 D12	3 Ø10	2 Ø10
Tul. tengah	4 Ø10	-	-
Tul. bawah	3 D12	3 Ø10	2 Ø10
Beugel	Ø8-100(tump) - Ø8-150 (lap)	Ø6-100(tump) - Ø6-150 (lap)	Ø6-100(tump) - Ø6-150 (lap)
selimut beton	30mm	20mm	20mm
kuualitas beton	K300	K250	K200
kuualitas besi	-	-	-

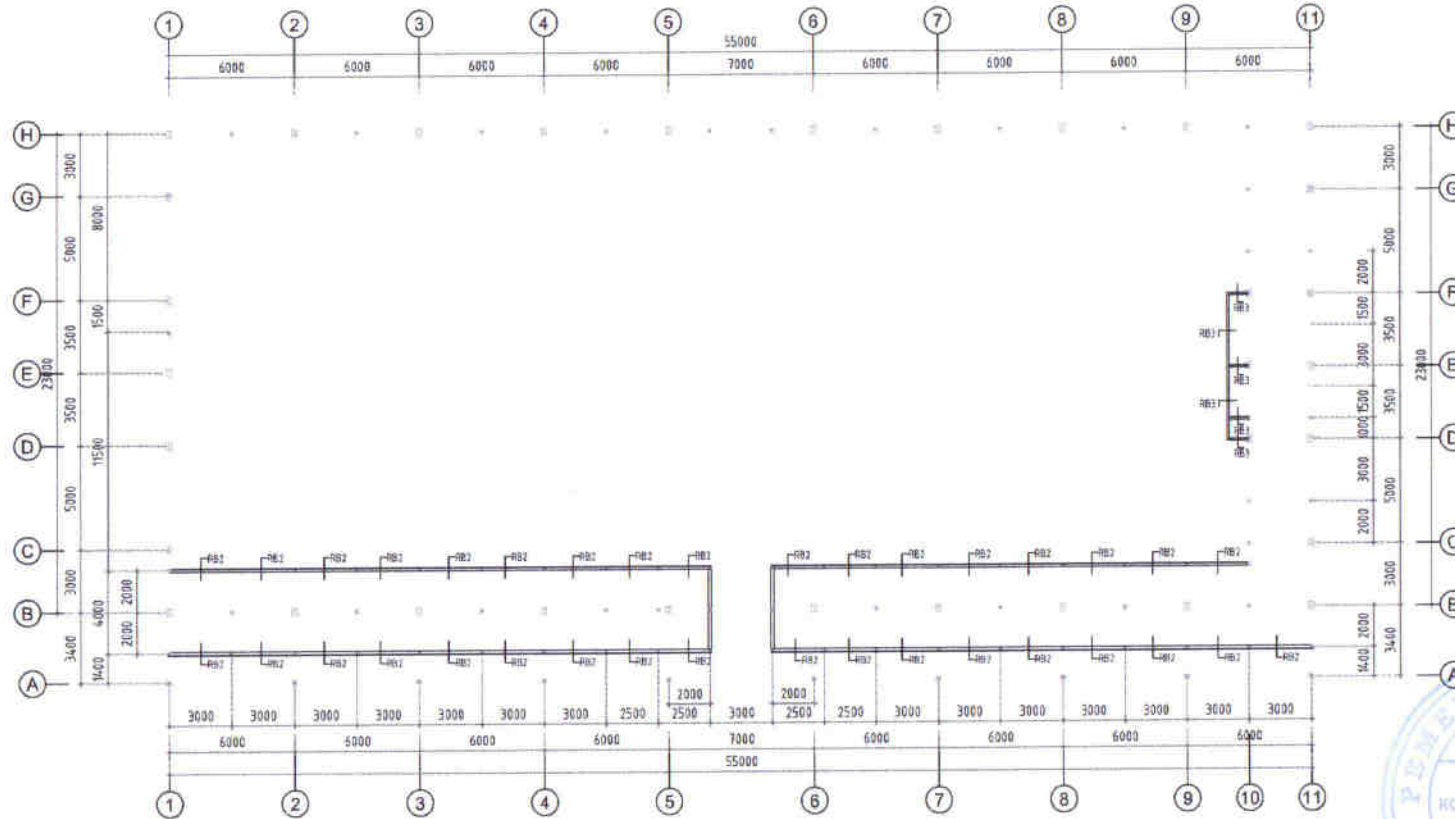

DENAH BALOK ELEV +2.40

SKALA 1:250

DETAIL KOLOM

DETAIL BALOK

TYPE	kolom 1 (K1)	kolom 2 (K2)	kolom 3 (K3)	kolom praktis (KP)	TYPE	Balok 1 (B1)	Ring balok 1 (RB1)	Ring balok 2 (RB2)	Ring balok 3 (RB3)
Skala 1:20					Skala 1:20				
Dimensi (mm)	250x350	180x180	130x130	130x130	Dimensi (mm)	350x150	130x250	130x150	200x100
Tulangan	4 Ø16	4 Ø12	4 Ø12	4 Ø10	Tulangan atas	-	2 Ø12	2 Ø10	-
Busur selimut beton	Ø6-100	Ø6-100	Ø6-100	Ø6-150	Tul. tengah	-	-	-	-
kuualitas beton	K300	K250	K250	K200	Tul. bawah	-	2 Ø12	2 Ø10	-
kuualitas besi	-	-	-	-	Busur selimut beton	-	Ø6-100(tump) - Ø6-150 (lap)	Ø6-100(tump) - Ø6-150 (lap)	-
					selimut beton	-	20mm	20mm	-
					kuualitas beton	-	K250	K200	-
					kuualitas besi	WF 300.150	-	-	WF 200.100

KETERANGAN

Detail Mund.
Rip Pilo

NO	REVISI	PARAF		
		RI	RE	RS

Detailan

Uraian



Menggambar

YETI LINDA KOPERASI USAHA MIKRO DAN PERDAGANGAN RUMAH PERUMAHAN

[Signature]
JANUS EP. WID.
KORPORASI

Menggambar

RENYATI PERBUDI KAWA TIKH OFFICE

[Signature]
SACHO SUPRIATNO, S.T., M.T.
KORPORASI

KONSULTAN GABUNG



TIARA PILAR KREASI, PT.

REVISI

LIYAN BILANDIN, ST, MT

STRUKTUR

KAWAHARIZDI OF

WIL

WIRANJUN, ST

Detail Project

Nama Gambar

DENAH RING BALOK ELEV 2.20

Skala

No. Gambar

1:250 & 1:20

No. Proyek

S.04

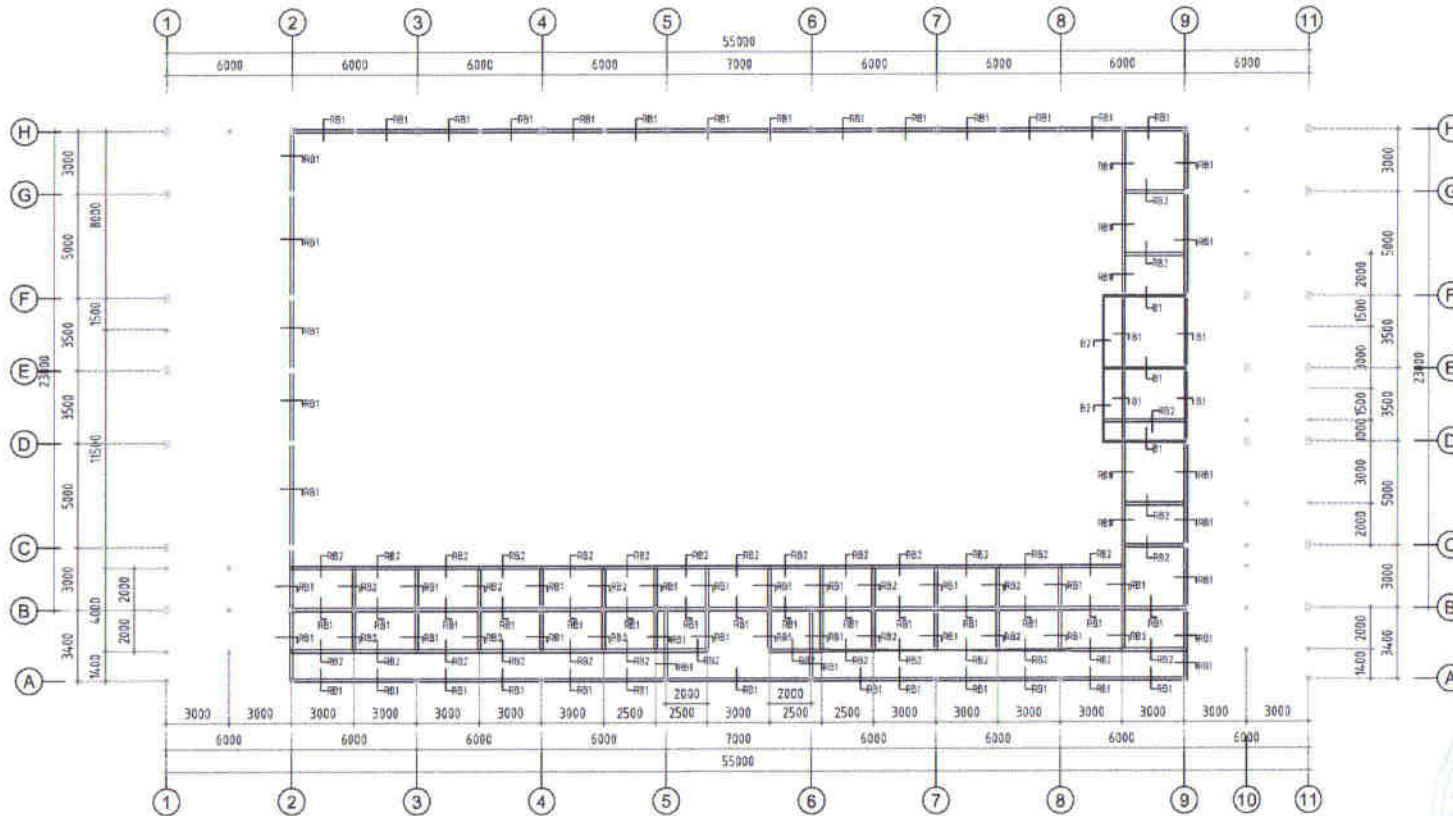

DENAH BALOK ELEV +3.20
SKALA 1:250

DETAIL KOLOM

DETAIL BALOK

TYPE	DETAIL KOLOM				TYPE	DETAIL BALOK			
	kolom 1 (K1)	kolom 2 (K2)	kolom 3 (K3)	kolom praktis (KP)		Balok 1 (B1)	Ring balok 1 (RB1)	Ring balok 2 (RB2)	Ring balok 3 (RB3)
Skala 1:20					Skala 1:20				
Dimensi (mm)	250x350	180x180	130x130	130x130	Dimensi (mm)	350x150	130x250	130x150	200x100
Tulangan	12 Ø16	4 Ø12	4 Ø12	4 Ø10	Tulangan atas	-	2 Ø12	2 Ø10	-
Beugel	Ø8-100	Ø6-100	Ø6-100	Ø6-150	Tul. tengah	-	-	-	-
selimut beton	30mm	20mm	20mm	20mm	Tul. bawah	-	2 Ø12	2 Ø10	-
kuualitas beton	K300	K250	K250	K200	Beugel	-	Ø6-100 (tump) - Ø6-150 (lap)	Ø6-100 (tump) - Ø6-150 (lap)	-
kuualitas besi	-	-	-	-	selimut beton	-	20mm	20mm	-
					kuualitas beton	-	K250	K200	-
					kuualitas besi	WF 300.150	-	-	WF 200.100

KETERANGAN

Daftar Riwayat Rev. Plan

NO	REVISI	PARAF		
		R1	R2	R3

Catatan



Manajemen & Engineering Services

PEMBANGUNAN DAN PERENCANAAN

TIARA PILAR KREASI, PT

TIARA PILAR KREASI, PT
Manajemen & Engineering Services

Daftar Riwayat Rev. Plan

Skala	No. Gambar	No. Proyek
1:250 & 1:20		S.03

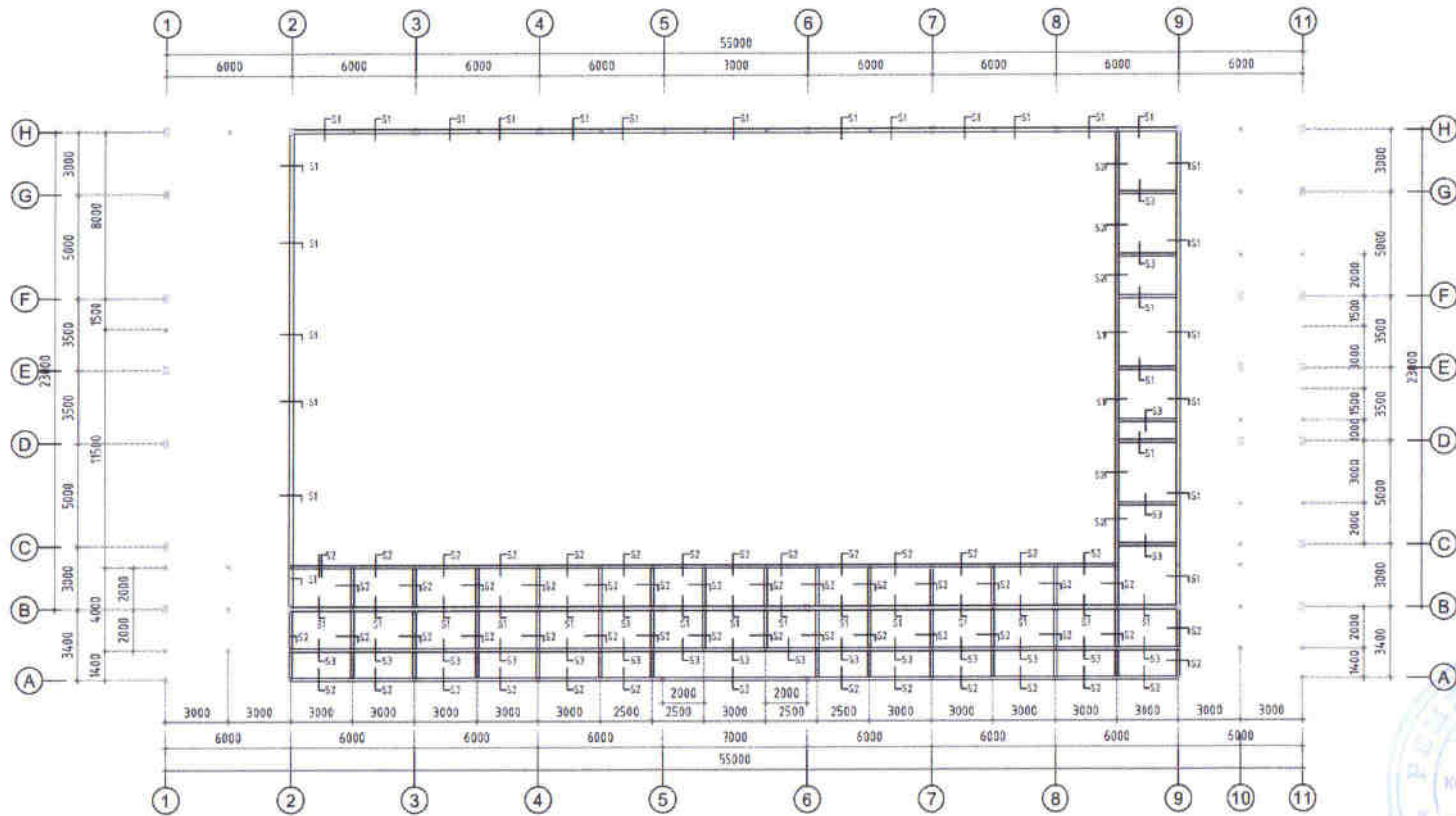

DENAH SLOOF
SKALA 1:250

KETERANGAN

Desain Bundar
Rajut Plan

NO	REVISI	PARAF		
		R1	R2	R3

Catatan



Manajemen
 HENRI OHA KOPERASI USAHA BUKIT DAN PERDAGANGAN
 KOTA PADANG

[Signature]
 MANAJEMEN PROJEK

Manajemen
 PERENCANAAN DAN KONSTRUKSI

[Signature]
 MANAJEMEN PROJEK

KONSULTAN GAMBAR

TIARA PILAR KREASI, PT
 Manajemen & Engineering Consultant
 Jl. Pemuda No. 100 Padang, Sumatera Barat

TSR TERIMA

INSPEKSI: LOUIS WANDAN, ST, MT

LITELATUR: MUHAMMAD STAR, ST

MAK: GABRIEL ZULH, ST

Desain
 Project

Name Gambar

DENAH SLOOF

Skala	No. Gambar	No. Proyek
1:250 & 1:20		S.02

DETAIL KOLOM

DETAIL SLOOF

TYPE	kolom 1 (K1)	kolom 2 (K2)	kolom 3 (K3)	kolom praktis (KP)	TYPE	Sloof 1 (S1)	Sloof 2 (S2)	Sloof 3 (S3)
Skala 1:20					Skala 1:20			
Dimensi (mm)	250x350	180x180	130x130	130x130	Dimensi (mm)	200x350	150x250	130x180
Tulangan	12 D16	4 Ø12	4 Ø12	4 Ø10	Tulangan atas	3 D12	3 Ø10	2 Ø10
Beugel	Ø8-100	Ø6-100	Ø6-100	Ø6-150	Tul. tengah	4 Ø10	-	-
selimut beton	30mm	20mm	20mm	20mm	Tul. bawah	3 D12	3 Ø10	2 Ø10
kuualitas beton	K300	K250	K250	K200	Beugel	Ø8-100(tump) - Ø8-150 (lap)	Ø6-100(tump) - Ø6-150 (lap)	Ø6-100(tump) - Ø6-150 (lap)
kuualitas besi	-	-	-	-	selimut beton	30mm	20mm	20mm
					kuualitas beton	K300	K250	K200
					kuualitas besi	-	-	-

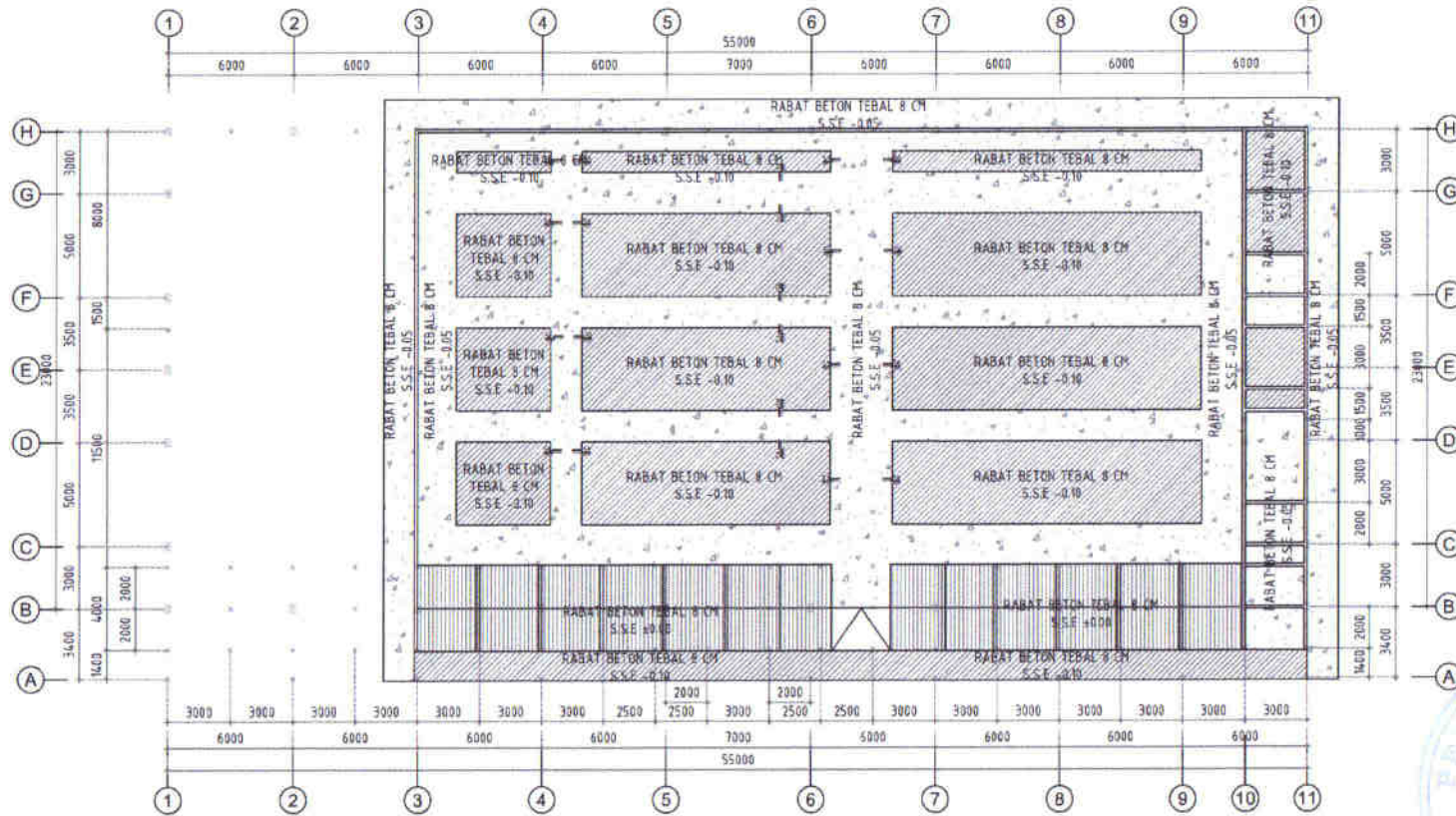

DENAH PLAT BETON LANTAI 1
SKALA 1:250

KETERANGAN :

- RABAT BETON TEBAL 8 CM
S.S.E. ±0.10
- RABAT BETON TEBAL 8 CM
S.S.E. ±0.05
- RABAT BETON TEBAL 8 CM
S.S.E. ±0.00
- S.S.E. : SLAB STRUCTURE ELEVATION
- : NOTASI PERBEDAAN ELEVASI



DENAH PLAT BETON LANTAI 2
SKALA 1:250

KETERANGAN

Daerah, Ruang, Kip, Pita

NO	REVISI	PARAF		
		RI	RS	RL

Catatan

Vision Client



Ministry of Trade
KEMENTERIAN PERDAGANGAN
REPUBLIK INDONESIA
Jl. P. H. H. S. No. 100
Jakarta Pusat, 10110, Indonesia

Manajemen

PEKERJAAN KONSULTAN, USAHA SAHA DAN PERDAGANGAN
KOTA PONTIANAK

[Signature]
JULIO S.P. W. S.
PEKERJAAN KONSULTAN

Manajemen

PEKERJAAN KONSULTAN KOTA PONTIANAK

[Signature]
RACHMAD SUPRIATNA S.H., M.S.
PEKERJAAN KONSULTAN

KONSULTAN CAMBUNG

TIARA PILAR KREASI, PT
Manajemen & Engineering & Architecture
Jl. Raya Garuda No. 100, Pontianak, Kalimantan Barat

TIM TEKNIK

ARQUITEK	LOKES TRIANDHANI, ST, MT
STRUKTUR	REHMANUL HAKEEM, ST
MSE	IKHARIZULHAQ, ST

Disusun
Project

PEKERJAAN KONSULTAN KOTA PONTIANAK

Nama Gambar

DENAH PLAT LANTAI

Skala	No. Gambar	No. Proyek
1:250		S.05

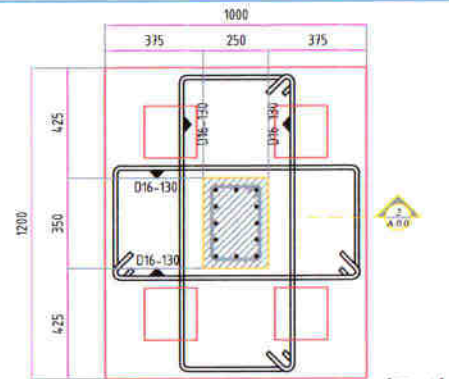

DETAIL PONDASI 1 (P1)

SKALA 1:20

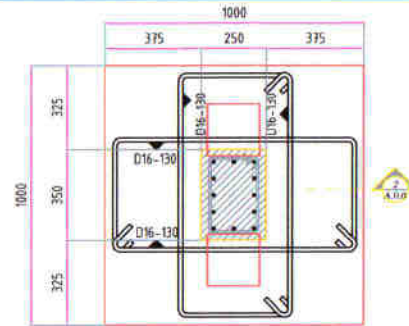

DETAIL PONDASI 2 (P2)

SKALA 1:20

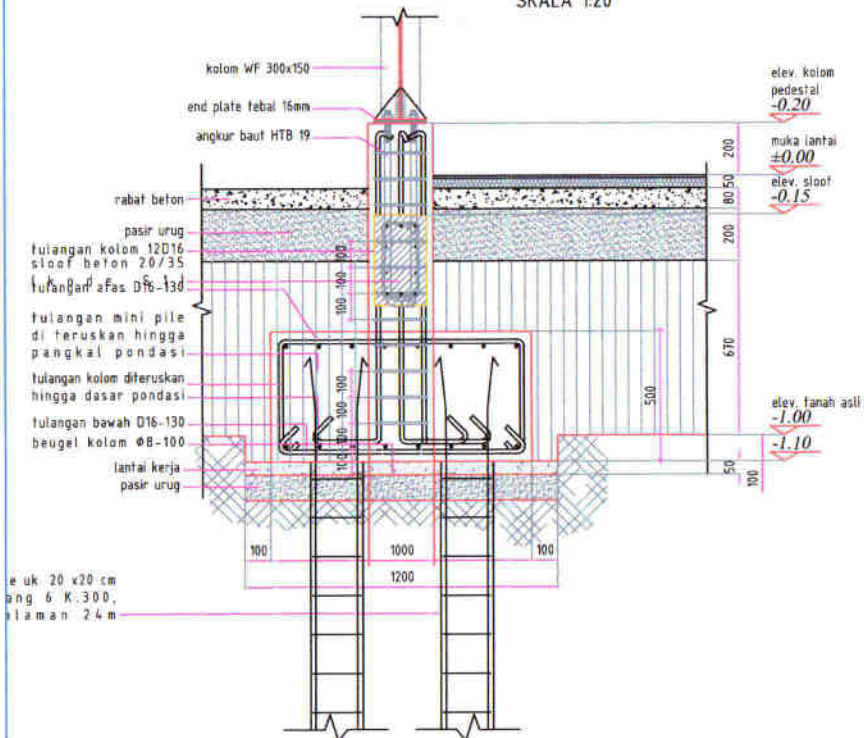

Potongan 1

SKALA 1:20

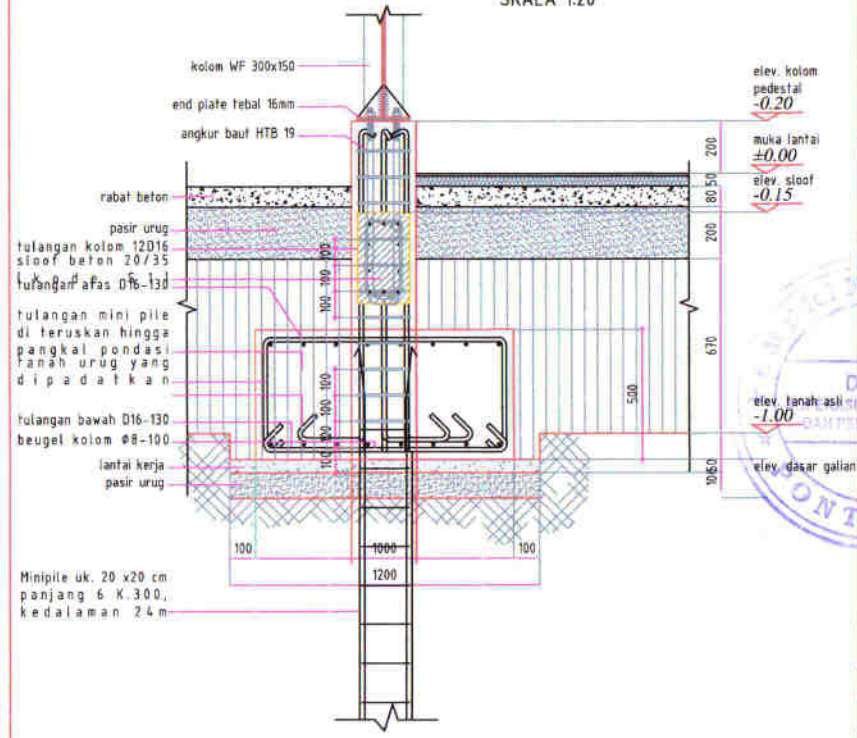

Potongan 1

SKALA 1:20

KETERANGAN

Daftar Rincian
Ker. Plan

NO	REVISI	PARAF		
		R1	R2	R3

Catatan

Logo
Client



Mengarahkan

KEMENTERIAN PERDAGANGAN
REPUBLIK INDONESIA
MINISTRY OF TRADE
OF THE REPUBLIC OF INDONESIA

KEMENTERIAN PERENCANAAN
KEFISIENAN DAN PERKOTAAN
KOTA PONTIANAK

DINAS

PERENCANAAN
MIRKO
DAN PERKOTAAN

PLANNING

PLANNING

PLANNING

PLANNING

PLANNING

PLANNING

PLANNING

PLANNING

PLANNING

PLANNING

PLANNING

PLANNING

PLANNING

PLANNING

PLANNING

PLANNING

PLANNING

PLANNING

PLANNING

PLANNING

PLANNING

PLANNING

PLANNING

PLANNING

PLANNING

PLANNING

PLANNING

PLANNING

PLANNING

PLANNING

PLANNING

PLANNING

SKALA

No. Gambar

No. Proyek

1:20

S.06

DETAIL PONDASI 1&2

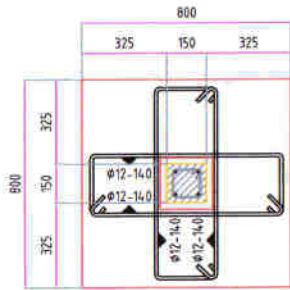

DETAIL PONDASI 1 (P1)

SKALA 1:20

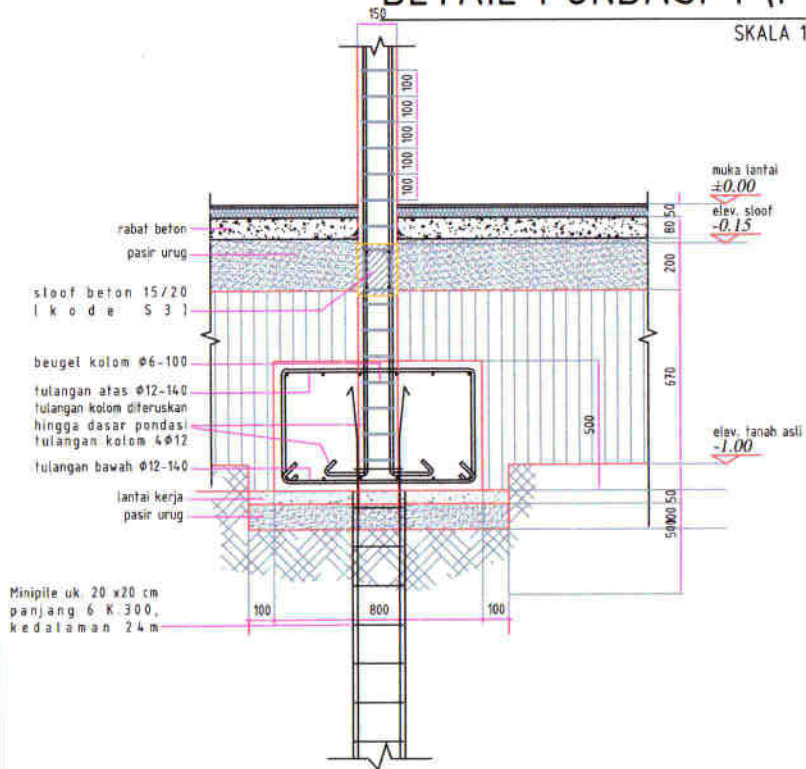

Potongan 1

SKALA 1:20

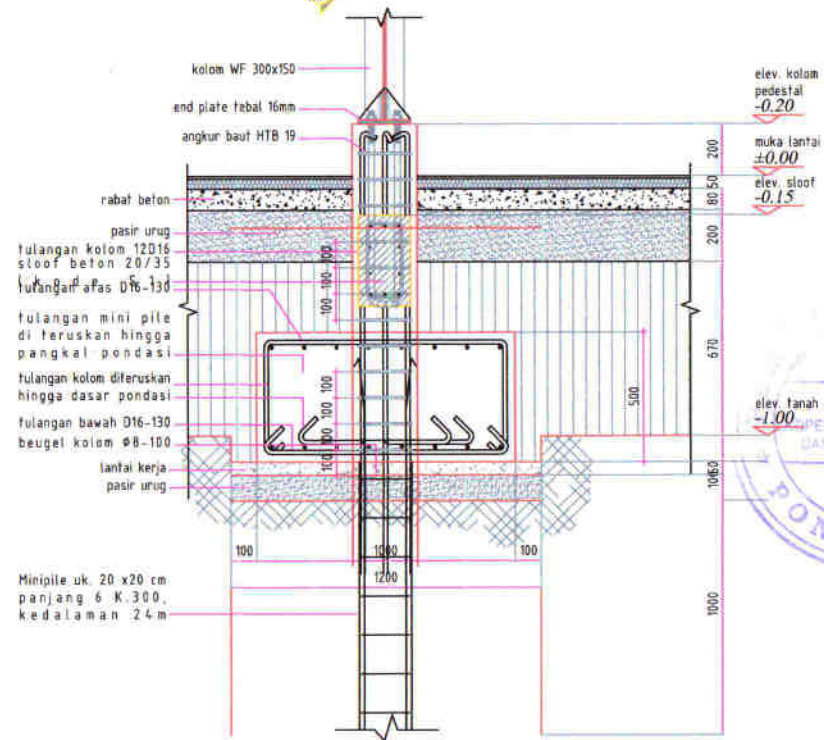
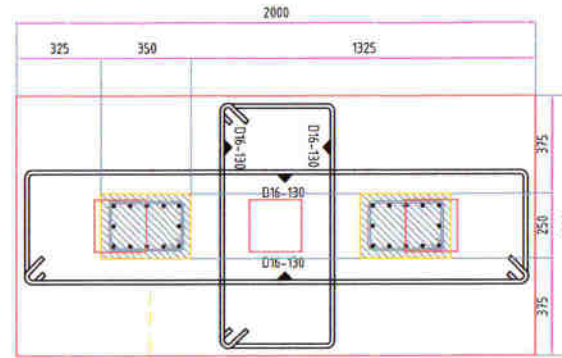

Potongan 1

SKALA 1:20

KETERANGAN

Demah Kumpul
Amp. Pile

NO	REVISI	PARAF		
		R1	R2	R3

Contoh

Logo



Menteri

KEPALA DINAS COBAKOR, USAH MENDU DAN PERDAGANGAN
KOTA PONTIANAK

(Signature)
KEMENTERIAN PERDAGANGAN
REPUBLIK INDONESIA

Menteri

PERENCANAAN PASAR PASARAWAL
DAN PERDAGANGAN (PEKAWI) PONTIANAK

KOORDINATOR

(Signature)
PONDASIPONTIANAK-01-01
PONTIANAK

KOORDINATOR

(Signature)
PONDASIPONTIANAK-01-01
PONTIANAK

KOORDINATOR

(Signature)
PONDASIPONTIANAK-01-01
PONTIANAK

KOORDINATOR

(Signature)
PONDASIPONTIANAK-01-01
PONTIANAK

KOORDINATOR

(Signature)
PONDASIPONTIANAK-01-01
PONTIANAK

KOORDINATOR

(Signature)
PONDASIPONTIANAK-01-01
PONTIANAK

KOORDINATOR

(Signature)
PONDASIPONTIANAK-01-01
PONTIANAK

KOORDINATOR

(Signature)
PONDASIPONTIANAK-01-01
PONTIANAK

KOORDINATOR

(Signature)
PONDASIPONTIANAK-01-01
PONTIANAK

KOORDINATOR

(Signature)
PONDASIPONTIANAK-01-01
PONTIANAK

KOORDINATOR

(Signature)
PONDASIPONTIANAK-01-01
PONTIANAK

KOORDINATOR

(Signature)
PONDASIPONTIANAK-01-01
PONTIANAK

KOORDINATOR

(Signature)
PONDASIPONTIANAK-01-01
PONTIANAK

KOORDINATOR

(Signature)
PONDASIPONTIANAK-01-01
PONTIANAK

KOORDINATOR

(Signature)
PONDASIPONTIANAK-01-01
PONTIANAK

KOORDINATOR

(Signature)
PONDASIPONTIANAK-01-01
PONTIANAK

KOORDINATOR

(Signature)
PONDASIPONTIANAK-01-01
PONTIANAK

Shala	No. Sember	No. Proyek
####		S.07

DETAIL PONDASI 3 & DETAIL STRUKTUR

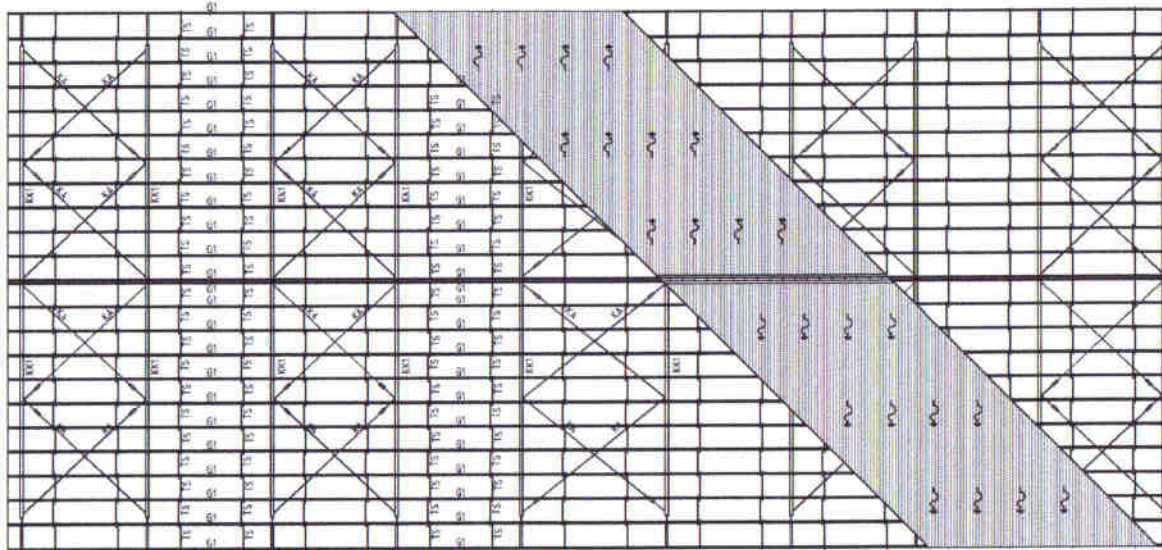

DENAH KUDA-KUDA1

SKALA 1:250

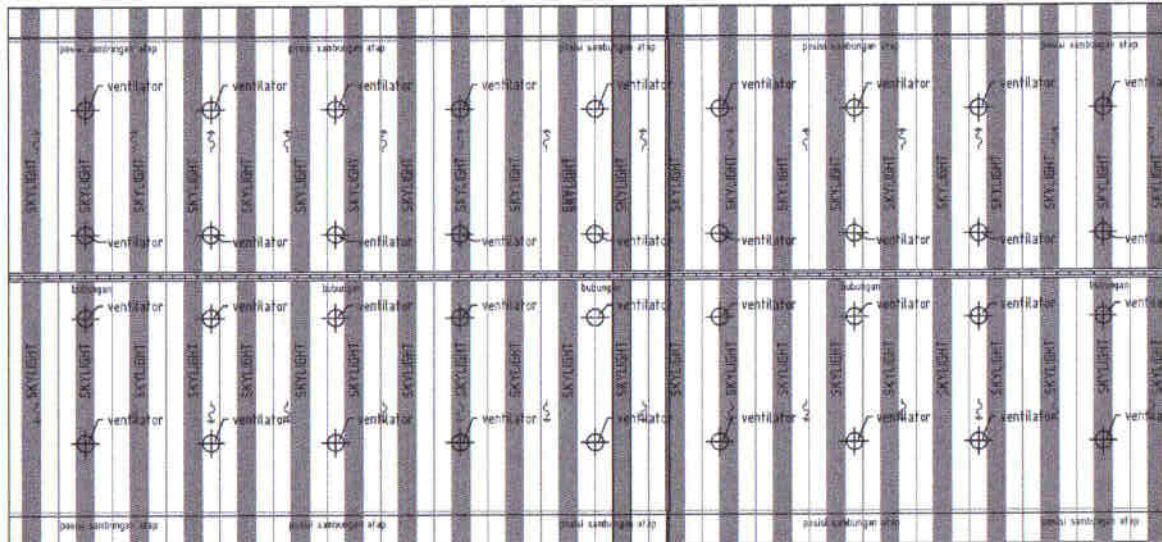

DENAH POLA ATAP

SKALA 1:250

KETERANGAN

Denda, Renda, Key Plan

NO	REVISI	PARAF		
		RI	R2	R3

Catatan

- KK1 : Kuda-kuda WF 300x150
- G1 : Gording Hanai C125
- KA : Kait Angin besi Ø16 dengan pengunci M16
- TS : Track Stano besi Ø10

Klien



MINISTRY OF TRADE
100 Puloan Road, Jakarta, Indonesia

Manajemen

KEPERUSAHAAN KOPERASI USAHA KERTAS DAN PERDAGANGAN
KOTA PONTIANAK



Manufaktur

PLANT MANUFACTURING (PMM)



SALIM SUKRI, S.T., M.Engg.

KONSTRUKSI GANDAR



TIARA PILAR KREANI, PT
Management & Engineering Consultant
Jl. Raya P. J. No. 100, Pontianak, Indonesia

TIM TEKNIS

ARHIT.	LOUISA INDIKSI ET, MT	
STRUKTUR	SAHARUDDIN ET, ST	
MES	SAHARUDDIN ET, ST	

Project

MANUFACTURING PLANT
TIARA PILAR KREANI, PT

Nama Gambar

DENAH ATAP UTAMA

Skala	No. Gambar	No. Proyek
1:250		5.08

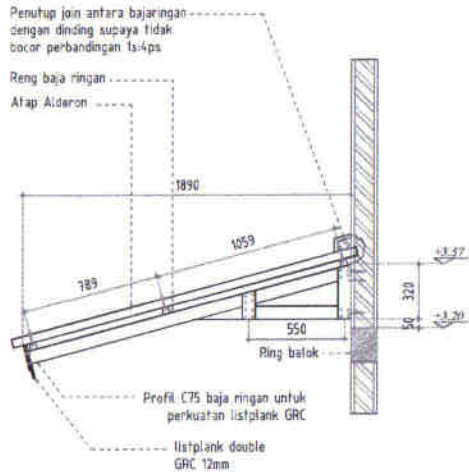

DETAIL KUDA-KUDA 3
SKALA 1:30

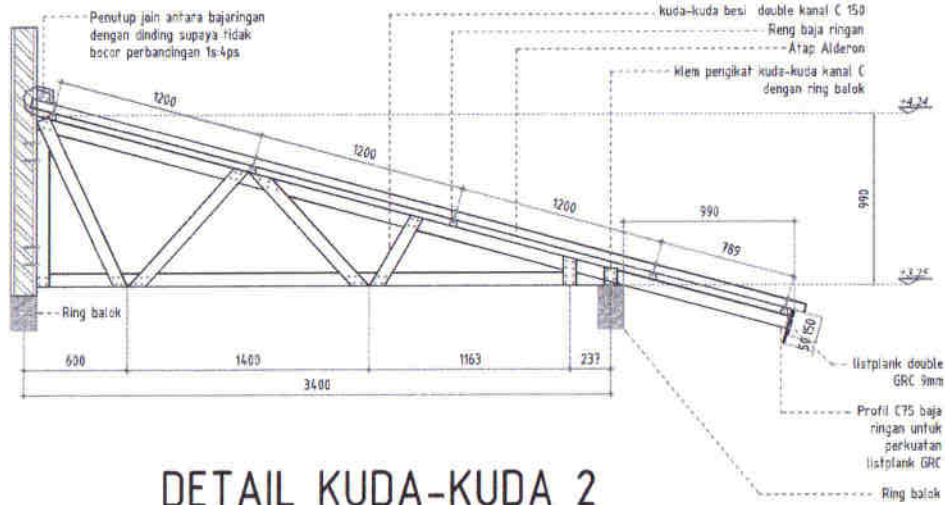

DETAIL KUDA-KUDA 2
SKALA 1:30

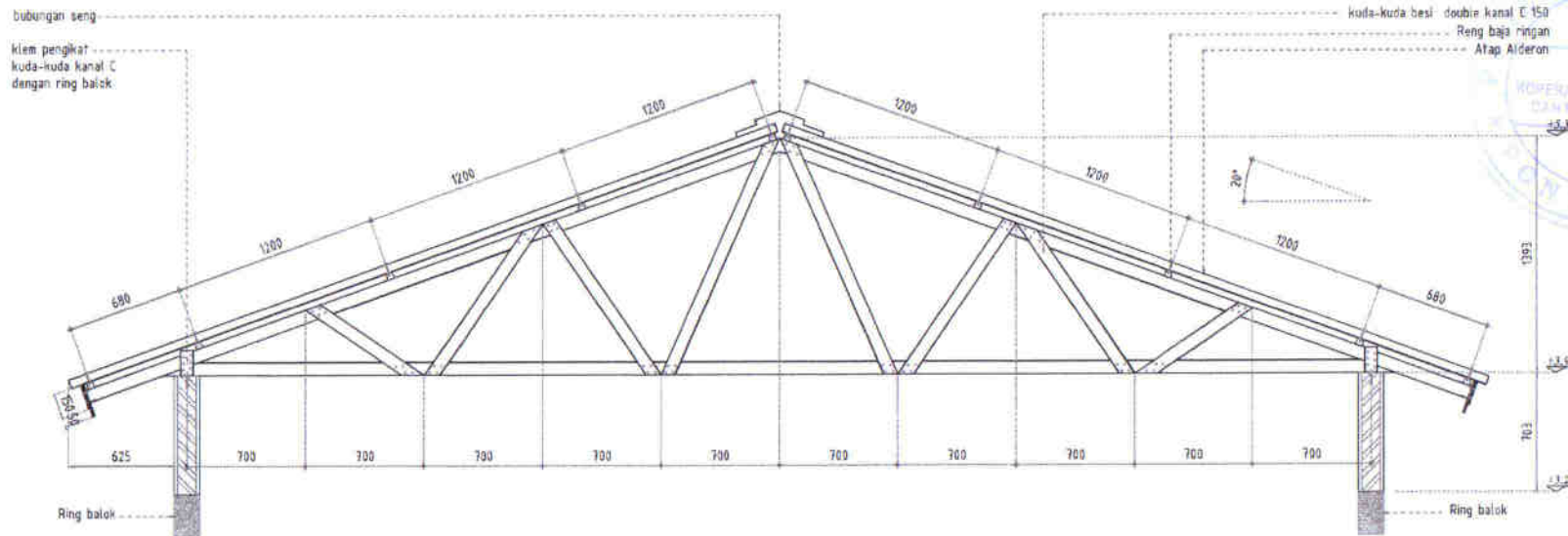

DETAIL KUDA-KUDA 4
SKALA 1:30

KETERANGAN

Dimensi Kuda-kuda
Key: A/B

NO	REVISI	PARAF		
		R1	R2	R3

Detail:



Mandulisul
KEPALA DINAS KOPERASI, USAHA BERSAMA SAMA DAN PERUSAHAAN
KOTA PONTIANAK

[Signature]
JUMUDI S.P., N.S.
17/05/2023

Mandulisul
PELAKSANA PEMERIKSA KAWASAN PONTIANAK

[Signature]
HASRINDA SUPRIATNA, S.T., M.T.
17/05/2023

KONSULTAN GAMBAR
TARA PILAR KREASI, PT
Ruang Kerja 2 & 3 - Gedung PT. Kalimantan
Jl. Pahlawan, 15-18 Jakarta

TEK. PERENCANA

WRITER: LOUISA INDAHAYU, ST., MT *[Signature]*

STRUKTUR: WAHABHICHAQ, ST. *[Signature]*

MEK: BRUNAWATI, ST. *[Signature]*

Contoh Project

[Signature]
TUGAS KAWASAN PONTIANAK

Nama Gambar

DETAIL KUDA-KUDA TERITISAN

Skala	No. Gambar	No. Proyek
1:30		S.14

DETAIL RIP 1
 BAHAN : PLAT BESI TEBAL
 KELENGKAPAN : -
 JUMLAH : 407



DETAIL RIP 2
 BAHAN : PLAT BESI TEBAL
 KELENGKAPAN : -
 JUMLAH : 40



DETAIL RIP 3
 BAHAN : POTONGAN WF 300
 KELENGKAPAN : -
 JUMLAH : 20



DETAIL RIP 4
 BAHAN : PLAT BESI TEBAL
 KELENGKAPAN : -
 JUMLAH : 530



RIP 4

DETAIL RIP 5
 BAHAN : POTONGAN WF 300
 KELENGKAPAN : -
 JUMLAH : 20

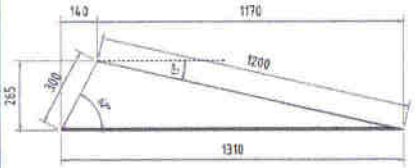

DETAIL RIP 6
 BAHAN : PLAT BESI TEBAL
 KELENGKAPAN : -
 JUMLAH : 72



DETAIL RIP 7
 BAHAN : POTONGAN WF 300
 KELENGKAPAN : -
 JUMLAH : 28



DETAIL END PLATE 1
 BAHAN : PLAT BESI TEBAL
 KELENGKAPAN : LUBANG BAUT ϕ 22MM
 JUMLAH : 33

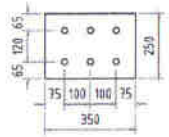

DETAIL END PLATE 2
 BAHAN : PLAT BESI TEBAL
 KELENGKAPAN : LUBANG BAUT ϕ 16MM
 JUMLAH : 20



DETAIL END PLATE 3
 BAHAN : PLAT BESI TEBAL
 KELENGKAPAN : LUBANG BAUT ϕ 19MM
 JUMLAH : 40



DETAIL END PLATE 1
 BAHAN : PLAT BESI TEBAL
 KELENGKAPAN : LUBANG BAUT ϕ 16MM
 JUMLAH : 18



KETERANGAN

Detail Rump.
Key Plate

NO	REVISI	MAREK		
		R1	R2	R3

Detail:

Logo of Kementerian Pekerjaan Umum dan Perumahan Rakyat (Ministry of Public Works and Housing) and logo of PT. TIARA PILAR KREASI, PT.

Mengetahui
 Kepala Dinas Perencanaan, Survei dan Pengukuran
 HQTA Pontianak

Mengetahui
 Kepala Proyek

MONGKILAN, GAMBAR

TIARA PILAR KREASI, PT
 Headquarters & Engineering Offices
 Jl. Raya Pematang Siantar, No. 11
 Kecamatan Pematang Siantar, Kabupaten Deli Serdang, Sumatera Utara

TIM TEKNIK

ANALIS : LIQUE (LILIANDELLA, ET., NT) 

STRUKTUR : MURNINGG (MURNINGG, ET., NT) 

MEK : BRINWAZULU, ET 

Proyek
 Project

Nama Gambar
 DETAIL RIP(SAMBUNGAN BURUL)

Skala	No. Gambar	No. Proyek
1:20		S.13

KEY PLAN

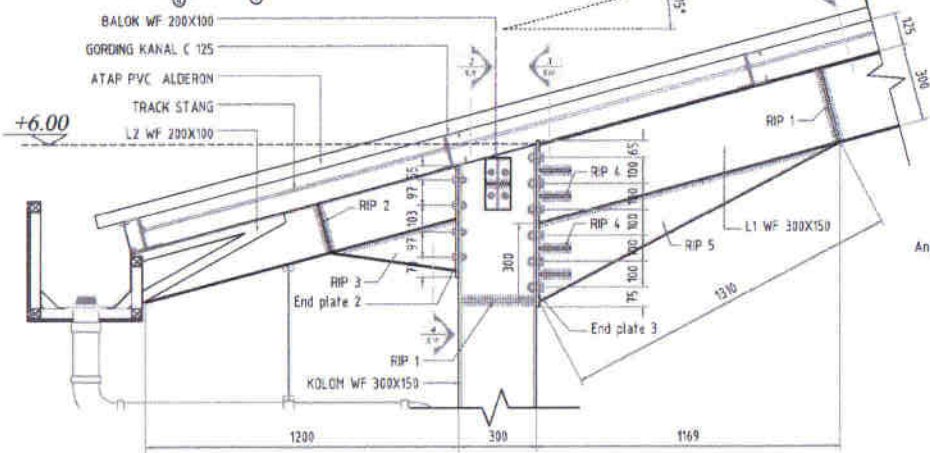
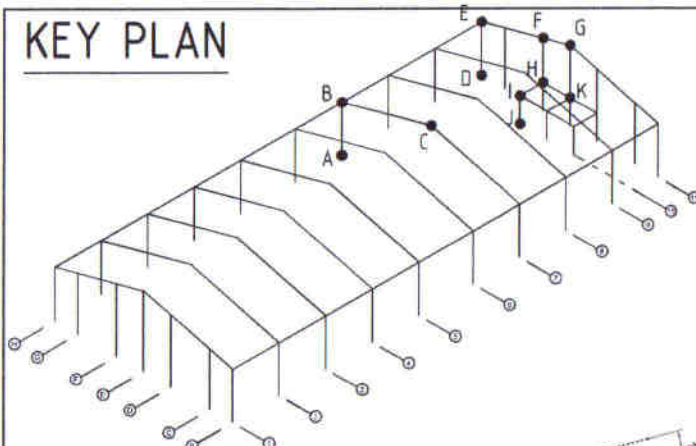

DETAIL B
SKALA 1:20

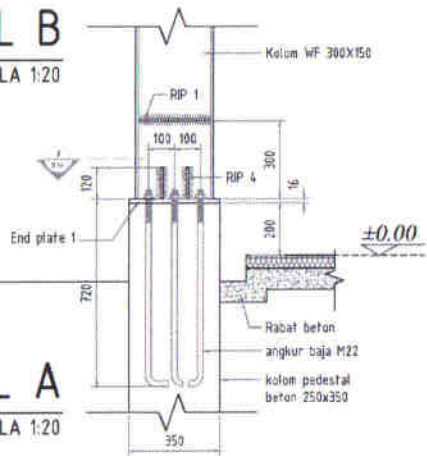

DETAIL A
SKALA 1:20

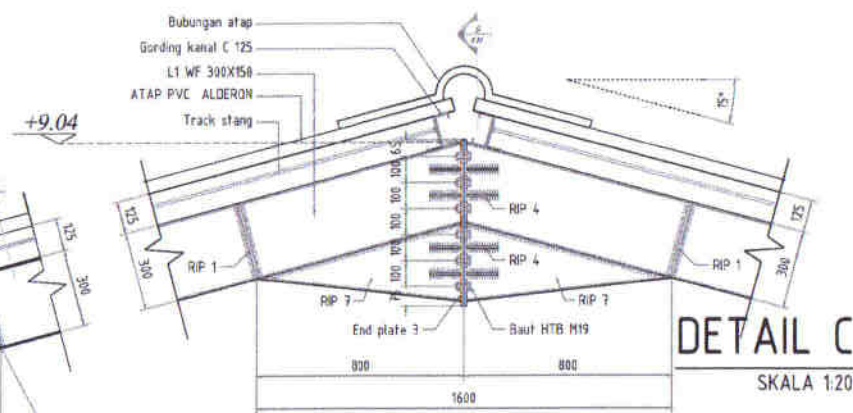

DETAIL C
SKALA 1:20

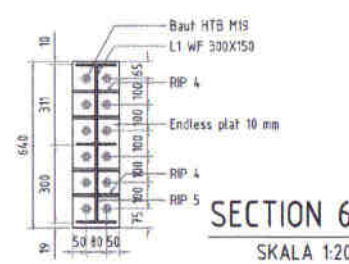
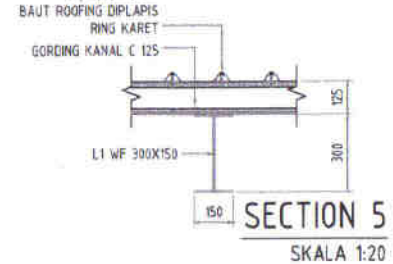
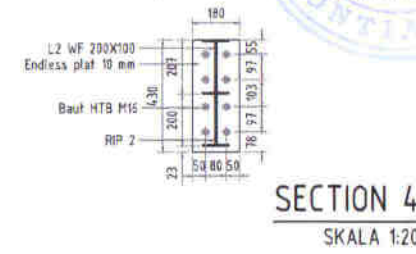
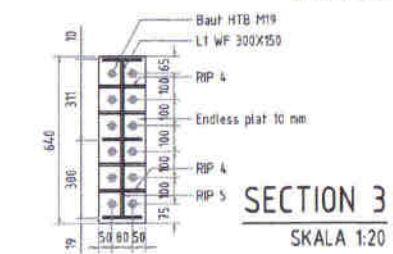
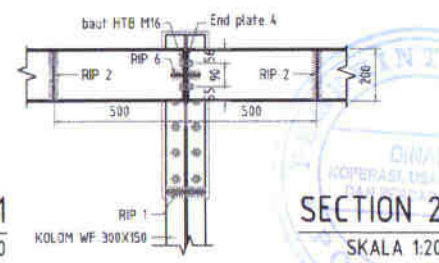
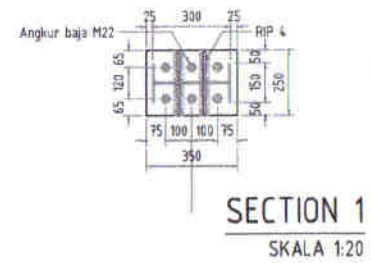

KETERANGAN

Darah Husein Key Plan				
NO		REVISI	PARAF	
			R1	R2 R3
Catatan				
 <p>KEMENTERIAN PERDAGANGAN REPUBLIK INDONESIA MINISTRY OF TRADE 10th Floor, Plaza First Bldg. 5 Jl. Pk. Plamb. 12115, Senayan</p>				
<p>Manajemen</p> <p>PERUSAHAAN DINAS KORPORASI (PT) (MILIK BERSAMA) PERUSAHAAN ANUGRAH PONTIANAK</p> <p><i>[Signature]</i> AHMAD SYAHRI DIREKTUR MANAJEMEN</p>				
<p>Manajemen</p> <p>PELAKSANAAN PERENCANAAN (PT) (MILIK BERSAMA) PERUSAHAAN ANUGRAH PONTIANAK</p> <p><i>[Signature]</i> SUKANDI SUPRIATNO, S.T., M.H. DIREKTUR MANAJEMEN</p>				
<p>KONSTRUKSI GABUNG</p> <p>PT TIARA PILAR KREANI, PT Manajemen & Engineering Consultant Jl. Pk. Plamb. 12115, Senayan</p>				
<p>TIM TEKNIK</p> <p>MISTEK: LOUISE WULANDARI, ST, MT <i>[Signature]</i></p> <p>STRUKTUR: SETHAWATI, ST, MT <i>[Signature]</i></p> <p>MEK: BRHMS, ST, MT <i>[Signature]</i></p>				
<p>Profil Project</p> <p>PT TIARA PILAR KREANI, PT Manajemen & Engineering Consultant Jl. Pk. Plamb. 12115, Senayan</p>				
<p>Nama Gambar</p> <p>DETAIL STRUKTUR BAJA PORTAL AS-7</p>				
Skala	No. Gambar	No. Proyek		
1:20		S.10		

KEY PLAN

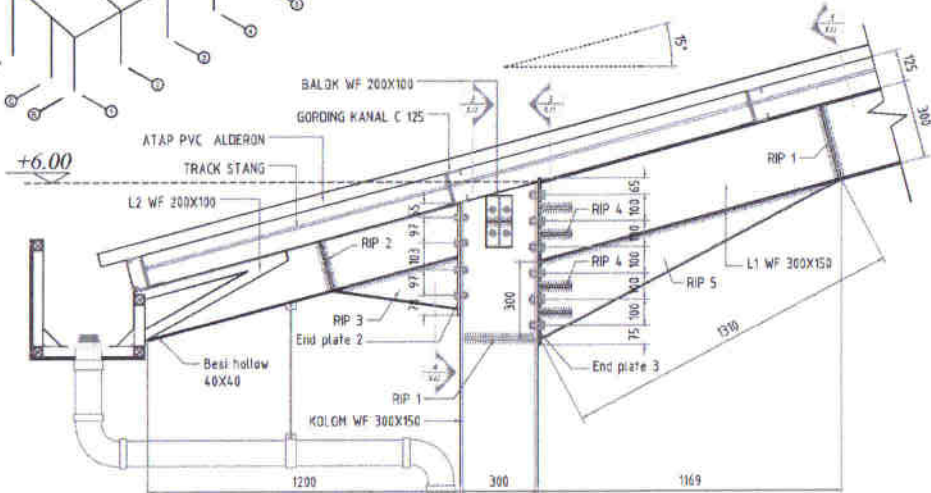
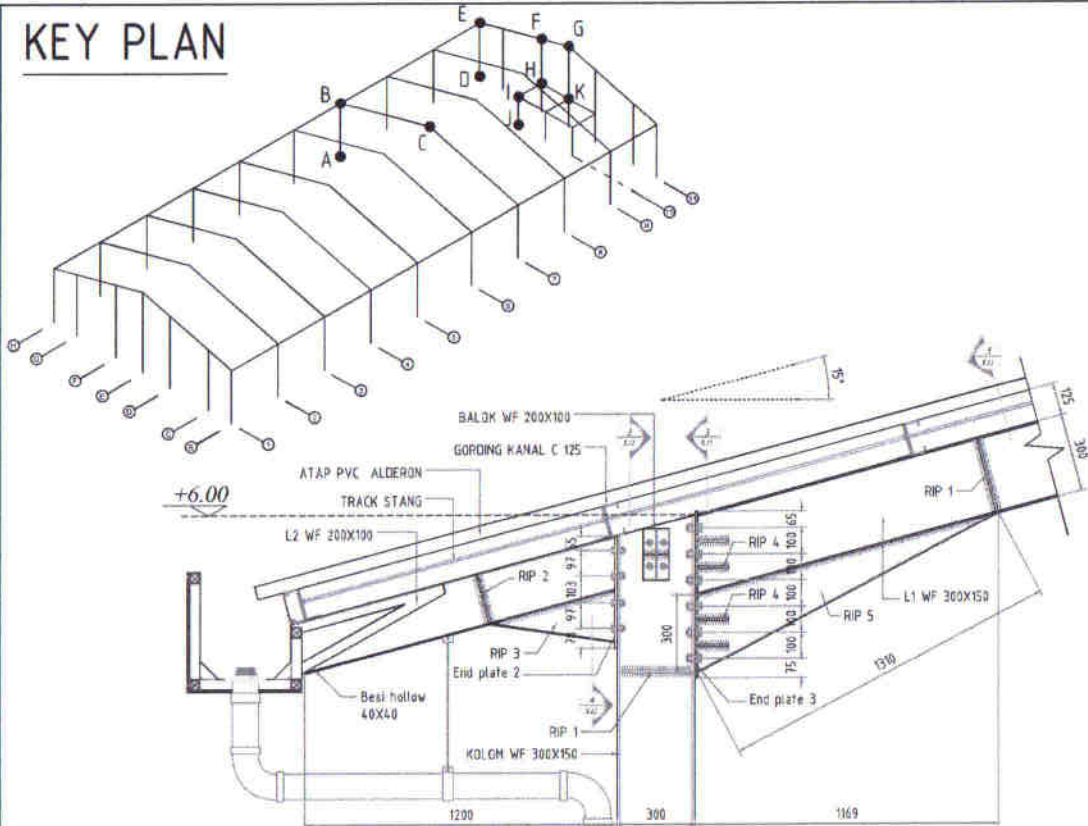

DETAIL E
SKALA 1:20

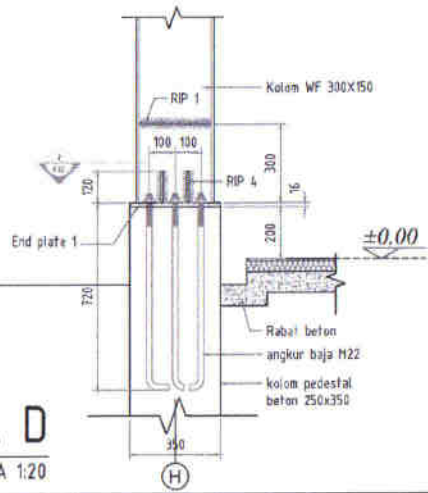

DETAIL D
SKALA 1:20

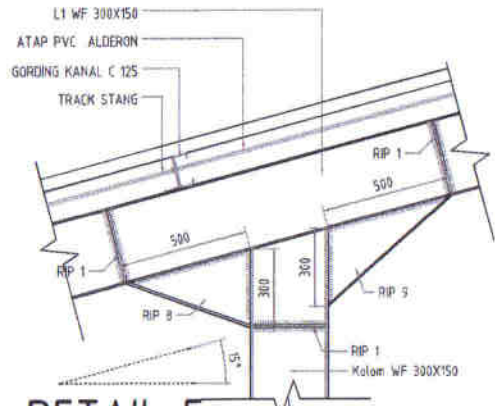

DETAIL F
SKALA 1:20

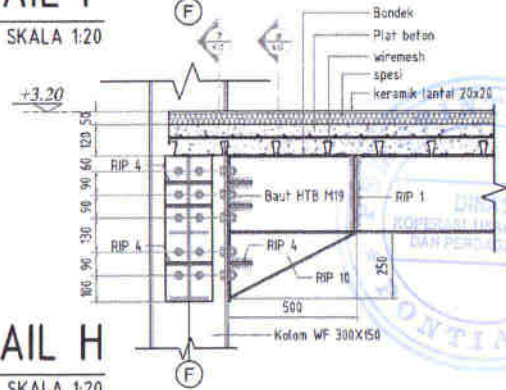

DETAIL H
SKALA 1:20

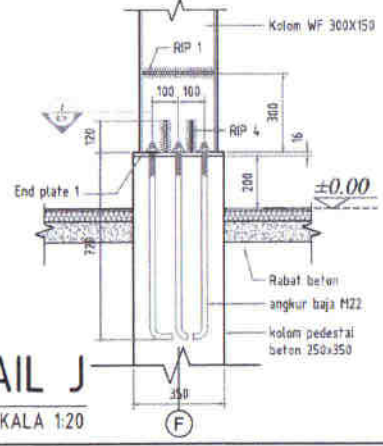

DETAIL J
SKALA 1:20

KETERANGAN

Denah Kandang
Ary Pilar

NO	REVISI	PAPAK		
		M1	M2	M3

Calatun



Marselohul
KEPALA DINAS STRUKTUR, UJIAN BENCANA DAN PERENCANAAN
NOTA PERENCANAAN

Marselohul
PELAKSI PROJEK/PEKERJA KONSULTAN

KONSULEN GAMBAR
ELARA PILAR KREASI, PT
Perancangan & Pelaksanaan Pekerjaan Teknik Sipil dan Struktur

TEKNIK BANGUNAN
DIBINA
DIREKTOR
DIT. STRUKTUR
DIT. STRUKTUR

Proyek
Proyek
PEKERJAAN STRUKTUR BAJA PORTAL AS-11 PART 1
DIT. STRUKTUR BAJA PORTAL AS-11 PART 1

No. Gambar	No. Proyek
120	S.11

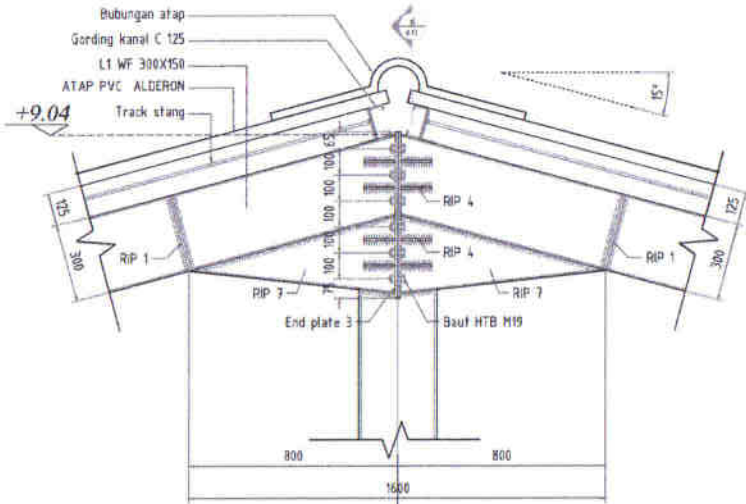

DETAIL G
SKALA 1:20

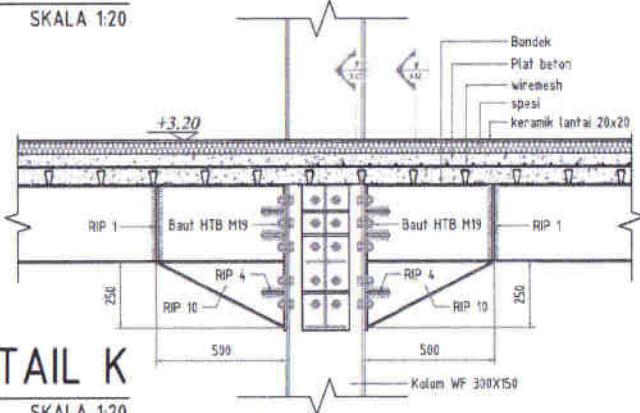

DETAIL K
SKALA 1:20

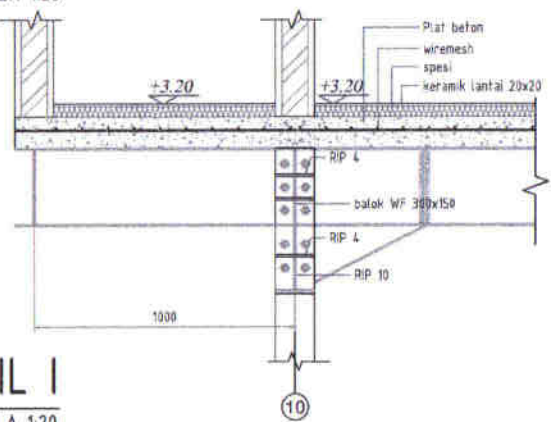

DETAIL I
SKALA 1:20

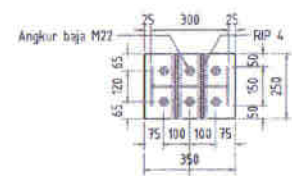

SECTION 1
SKALA 1:20

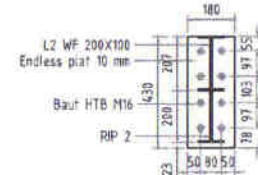

SECTION 3
SKALA 1:20

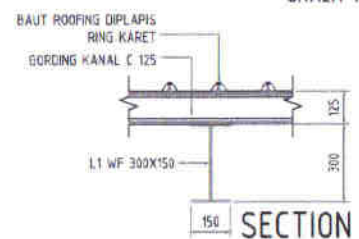

SECTION 5
SKALA 1:20

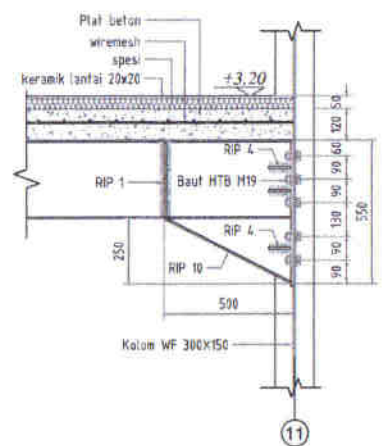

SECTION 7
SKALA 1:20

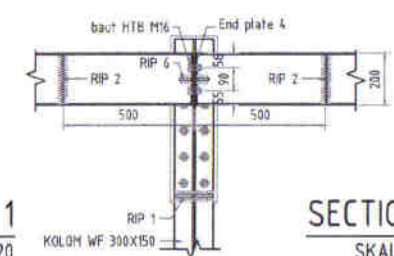

SECTION 2
SKALA 1:20

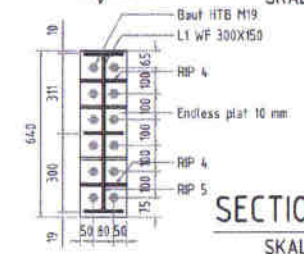

SECTION 4
SKALA 1:20

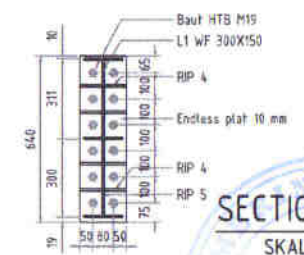

SECTION 6
SKALA 1:20

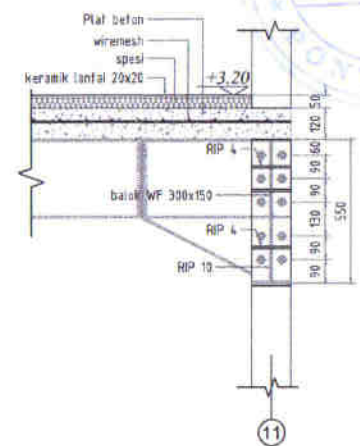

SECTION 8
SKALA 1:20

KETERANGAN

NO	REVISI	PAPAK	
		R1	R2

Daftar



Manajemen
KERALA DINAS KOPERASI, USAHA BERSAMA DAN PERUSAHAAN
KOTA PORTOKARA

Manajemen
PELAKSI PERSEKUTUAN KOPERASI

KONSULTAN GAMBAR
KIARA PILAR KREASI, PT
Perancangan & Konstruksi Komerensial
Jl. Raya Pahlawan No. 10
Kec. Bukit Duri, Kota Pekanbaru, Riau

TOPIK KEDIRIAN
ARQUITEK LOUISE HILLANDI, ST., MT
STRUKTUR MAMUNGKALAN, ST
MEE WAWANZAL, ST

Daftar
Project
TUGAS PERENCANAAN STRUKTUR BAJA

Norm Gambar

DETAIL STRUKTUR BAJA PORTAL AS-11 PART 2

Skala	No. Gambar	No. Proyek
1:20		5.12

DET. POT 1

SKALA 1:10

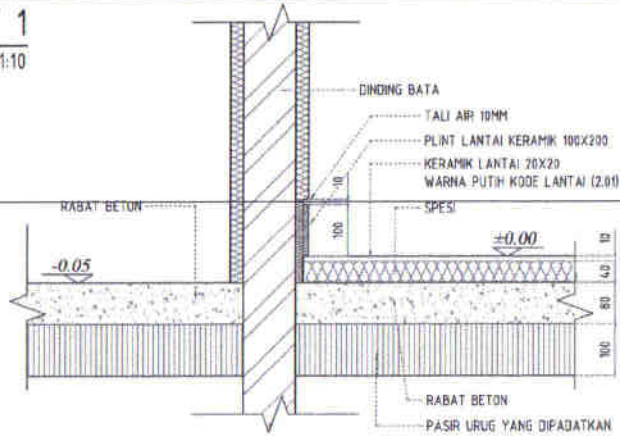

DET. POT 2

SKALA 1:10

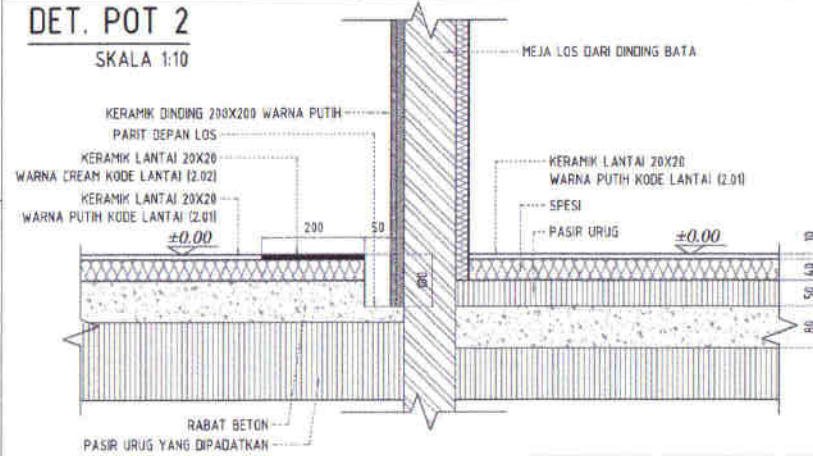

DET. POT 3

SKALA 1:10

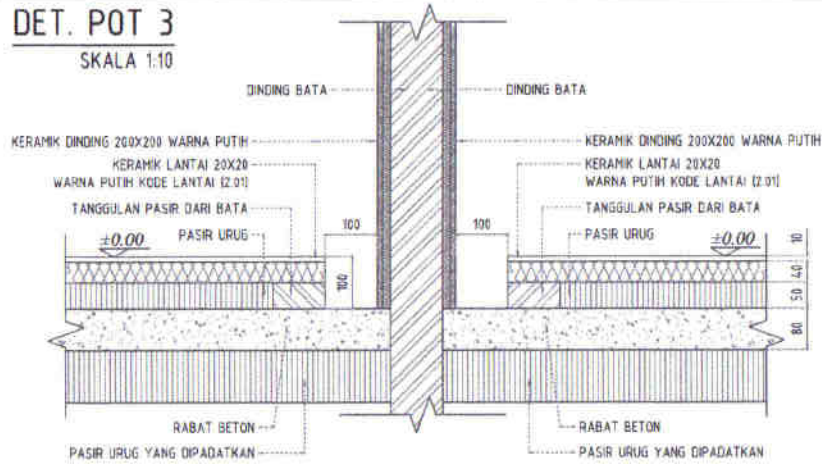

DET. POT 4

SKALA 1:10

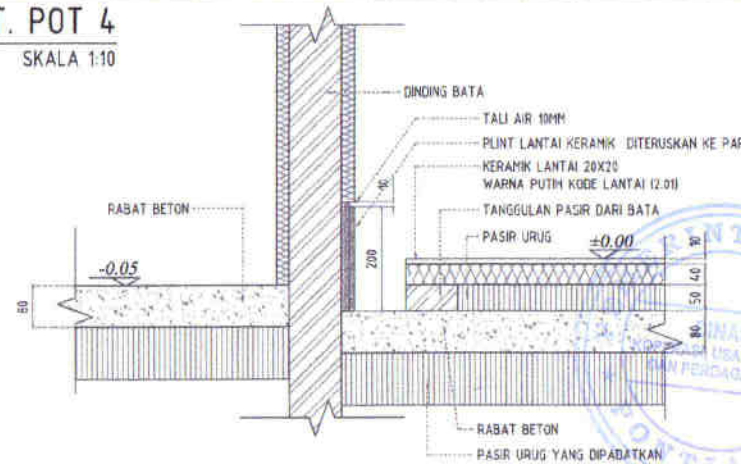

DET. POT 5

SKALA 1:10

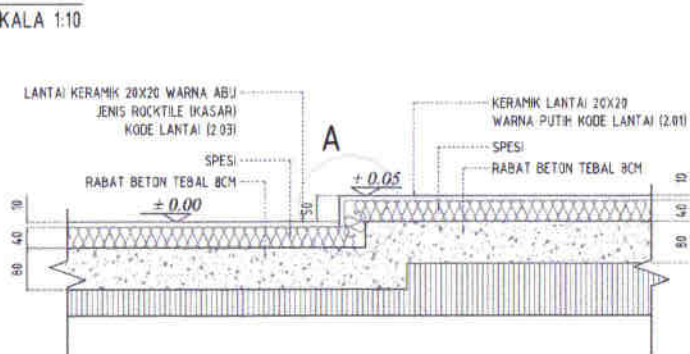

DET. POT 6

SKALA 1:10

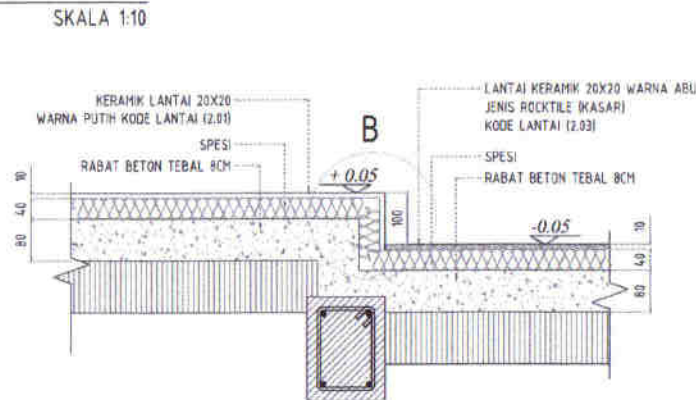

KETERANGAN

NO	REVISI	PARAF		
		PI	RI	RS

Disetujui
 Disetujui
 Disetujui



Mengetahui
 Kepala Dinas Koperasi, Usaha Kecil dan Perumahan Kota Padang
 (Signature)

Mengetahui
 Pejabat Pembuat Keputusan Teknik
 (Signature)

Disetujui
 (Signature)

YIN TERUS

MIREN: LOUIS KILANDAL ST., MT

STRUKTUR: BAHANJALAN ST

MEK: BRUNWZJAL ST

Disetujui
 (Signature)

Nama Gambar:

DETAIL PEMASANGAN KERAMIK

Skala	No. Gambar	No. Proyek
1:10		A.26

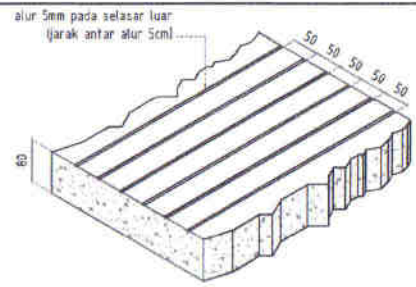
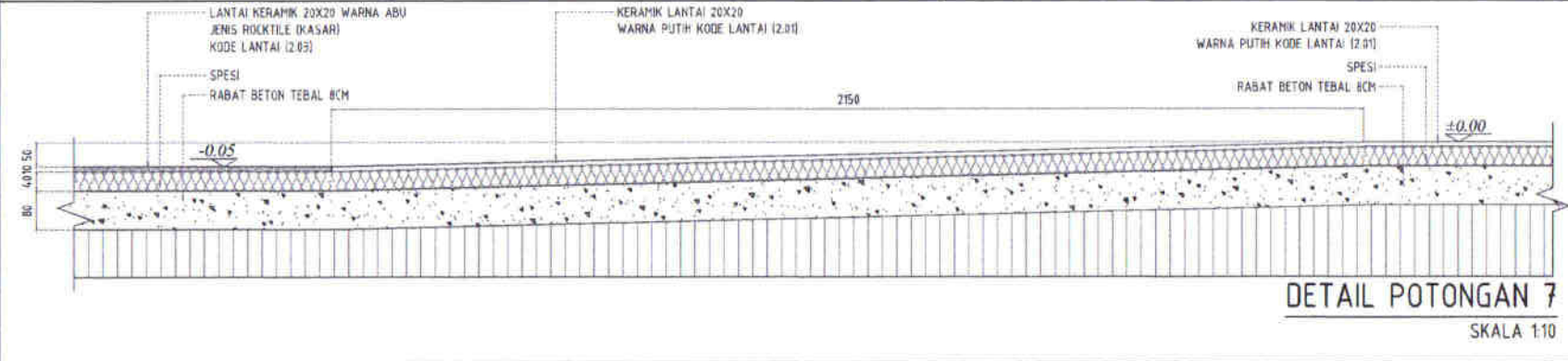
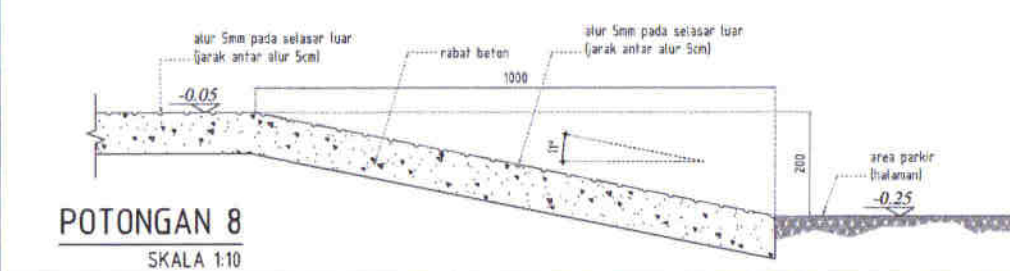
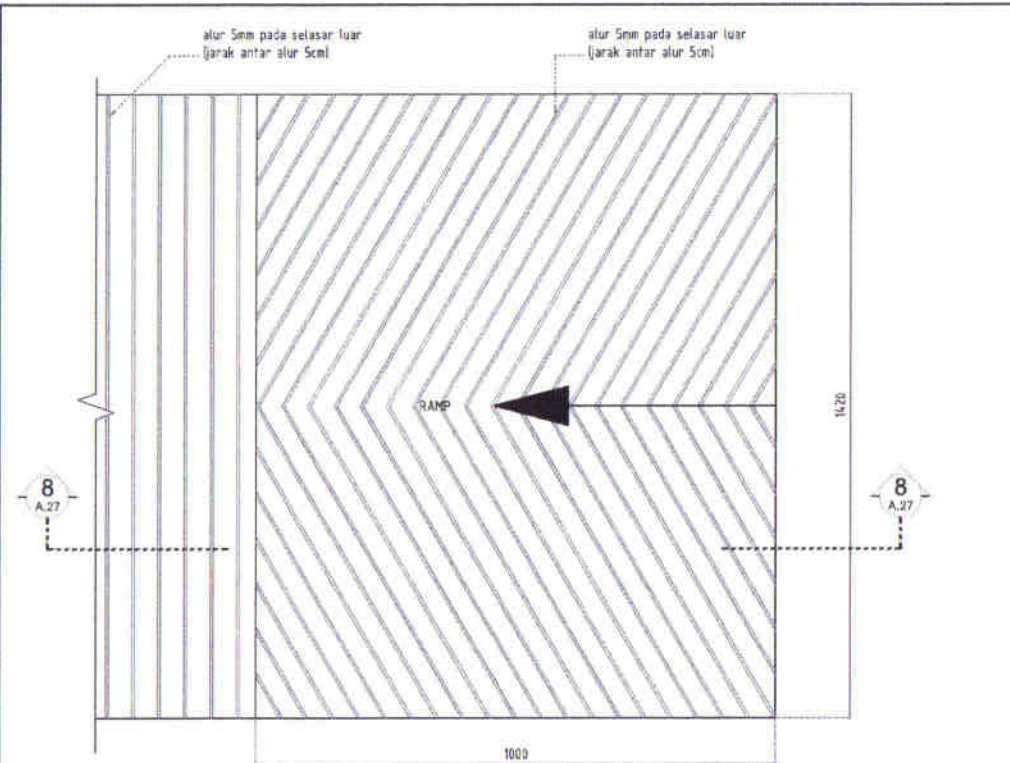

ISOMETRI TALI AIR SELASAR
SKALA 1:10

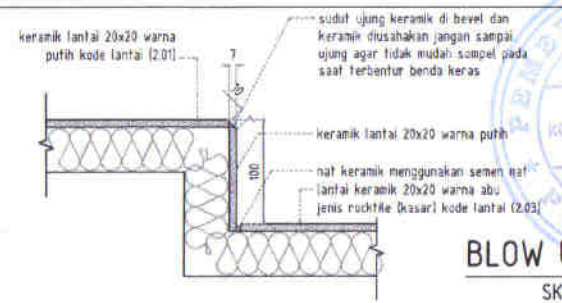
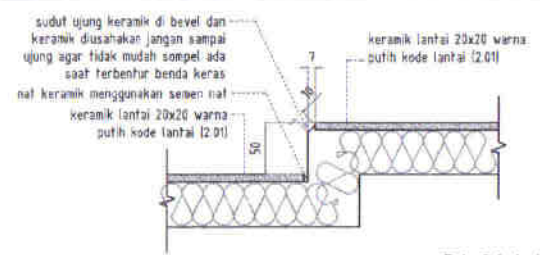

KETERANGAN

Desk. Trans. / Lay. Plan

NO	REVISI	PAPAN		
		R1	R2	R3

Client



Client

Manfaat
KEPALA DINAS KEPURBAKAWALAN DAN PENGANTARAN
KOTA PONTIANAK

Manfaat
PROJEK PEMBANGUNAN FAKTORI PPMN

KONSULTAN GAMBAR
TIARA PILAR KREASI PT

TIM REVISI
REVISI: LOUIS KULINDRAL ST, ST
STRUKTUR: WAHIDHUGENI ST
MEK: BRUNAZULIA ST

Detail Ramp dan Blow Up Detail Keramik

Skala	No. Gambar	No. Proyek
1:10 & 1:5		A.27

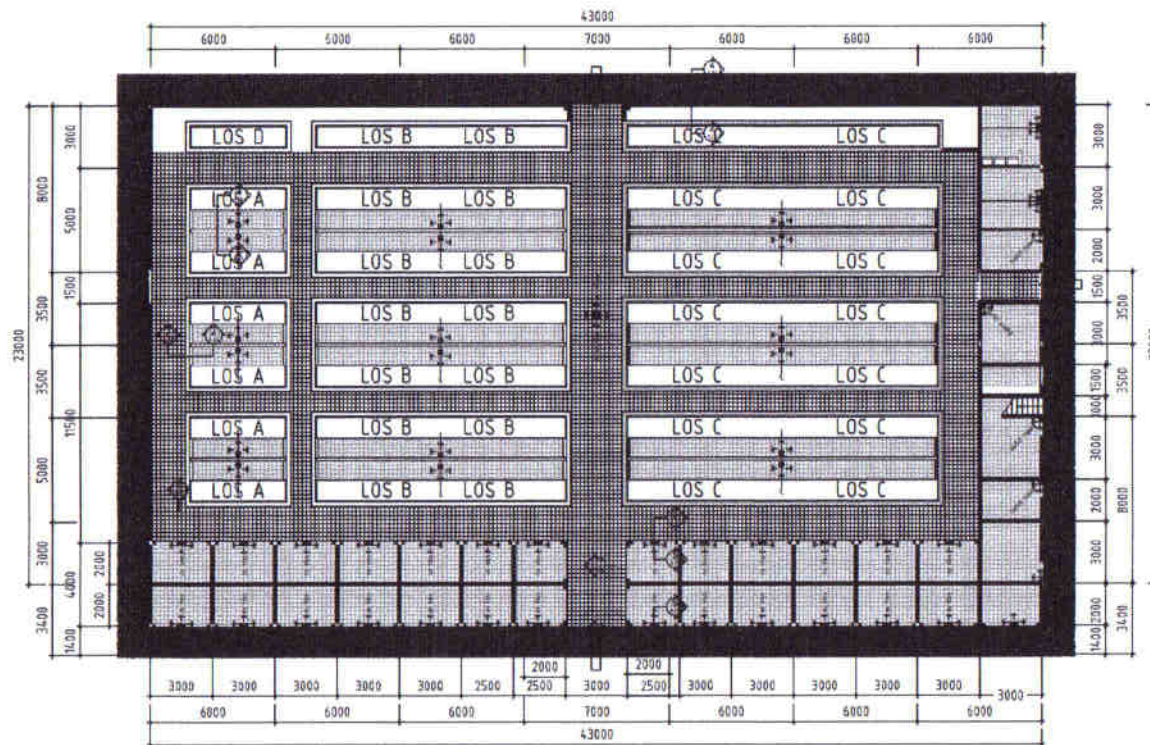

KETERANGAN

Denah Lantai
Key Plan

NO	REVISI	PARAF		
		RT	R2	R3

- Legenda**
- LANTAI KERAMIK WARNA PUTIH 20X20 GLOSSY ELEVASI ±0.00 (KEUALI K002)
 - LANTAI KERAMIK WARNA CREAM 20X20 GLOSSY
 - LANTAI KERAMIK WARNA ABU 20X20 JENIS ROCKTILE (KASARI) ELEVASI LANTAI ±0.05
 - PADAT BETON SELUR BARS KASARI ELEVASI ±0.05
 - ACUAN PEMALANGAN POLA KERAMIK



Konvensional
KEPALA DINAS KOPERASI, USAHA MIKRO DAN PERENCANAAN KOTA PONTIANAK
DINA
DINAS KOPERASI, USAHA MIKRO DAN PERDAGANGAN
PONTIANAK

Merencanakan
TUJUH BELAS BELAS KOPERASI (P) 0000
DINAS KOPERASI, USAHA MIKRO DAN PERDAGANGAN
PONTIANAK

KORPORATIF GAMBAR
TIARA PILAR KREASI, PT
Manajemen & Engineering Consultant
Jl. ...

TIM TEKNIS

INSYENIR	USUBE SALANGUN, ST, MT	
STRUKTUR	WILGABANG FAL ST	
MEK	RIYAN ZULH, ST	

Direksi
Project
PERENCANAAN PASAR PARSAWAL TИPE C - PONTIANAK

Nama Gambar

Scale	No. Gambar	No. Profil

DENAH POLA LANTAI
SKALA 1:25



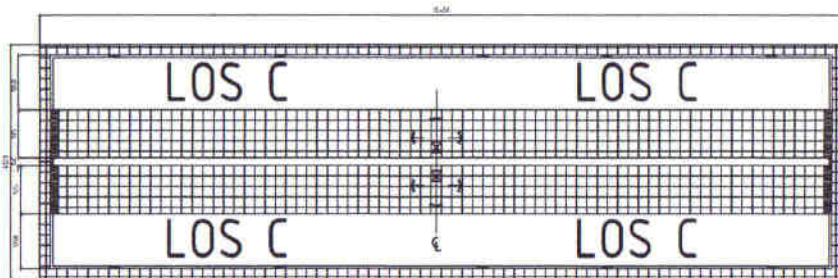
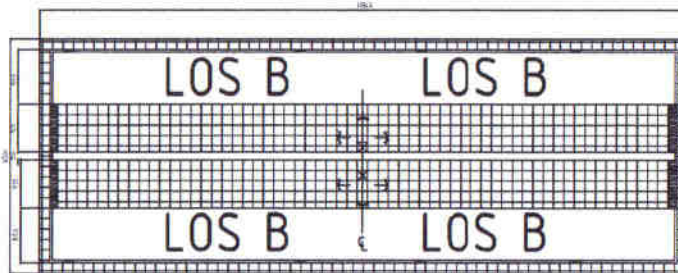
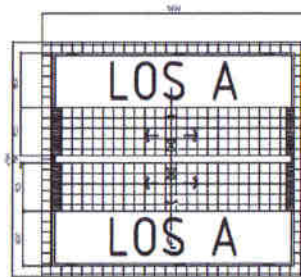

KETERANGAN

Detail Lantai
Key Plan

NO	REVISI	PAREW		
		RT	R2	R3

Detail

Star
Client



MINISTRY OF TRADE
REPUBLIC OF INDONESIA

Manufaktur

REPUBLIK INDONESIA
KOPERASI USAHA DAN PERUSAHAAN
KODE PERUSAHAAN

[Signature]
DINAS
KOPERASI USAHA
DAN PERUSAHAAN
PONTIANAK

Manufaktur
GABUNG

PENYAJI POKOK KOTAMADYA (PKK)

[Signature]
DINAS
KOPERASI USAHA
DAN PERUSAHAAN
PONTIANAK

KONSULTAN GAMBAR



TIARA PILAR KREASI, PT
Management & Engineering Consultant
PONTIANAK

THE TECHNICAL

PEKERJA	LOKASI KALANGKAP, RT, RT	<i>[Signature]</i>
STRUKTUR	MURAHARDYAN, RT	<i>[Signature]</i>
MES	WIRAHADI, RT	<i>[Signature]</i>

Detail
Project

PERENCANAAN PASAR PARSAWAL
Tipe C - PONTIANAK

Name Gambar

DETAIL POLA LANTAI LOS

SKALA 1:250

Judul	No. Gambar	No. Proyek



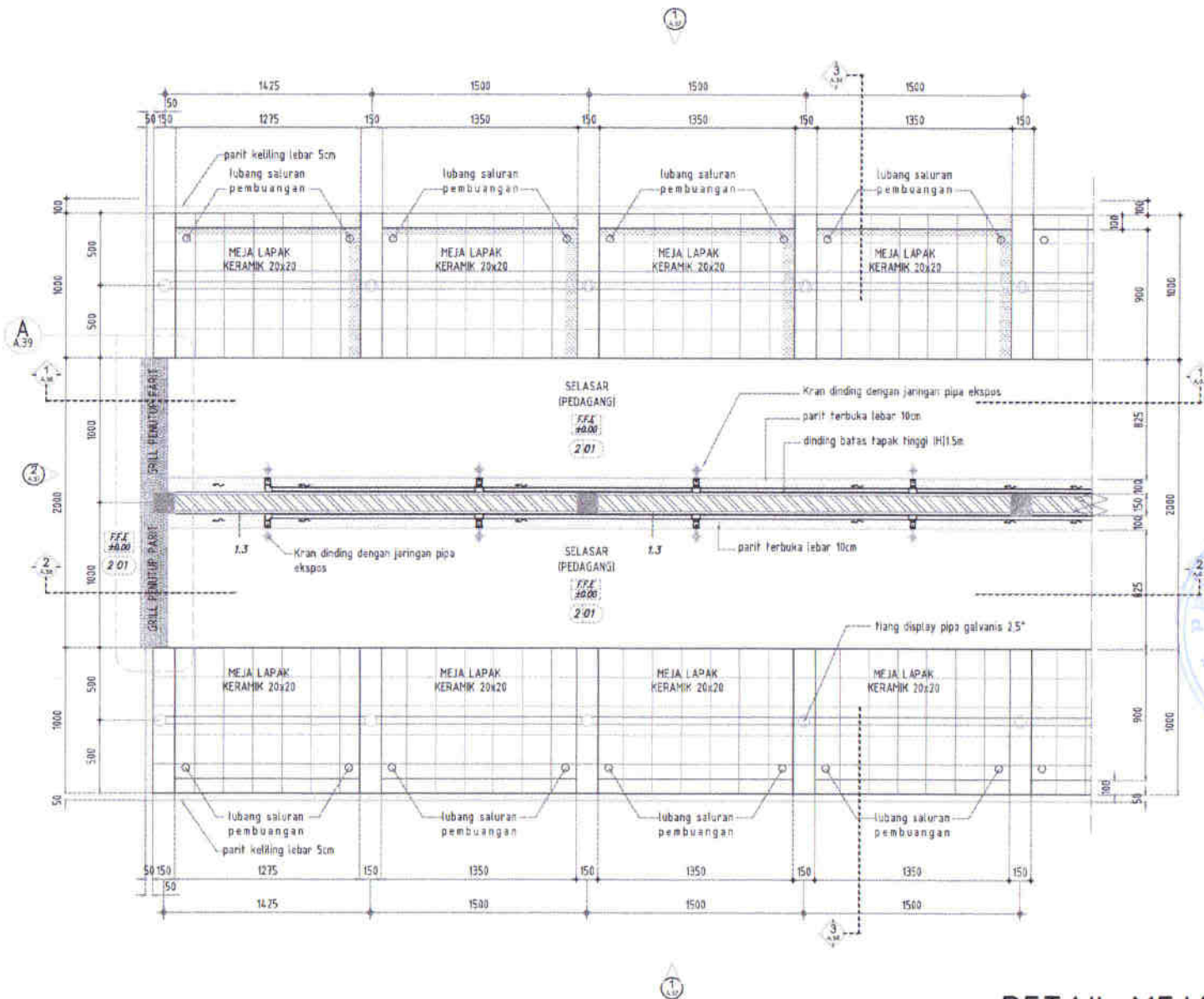

DETAIL MEJA LOS

SKALA 1:30

KETERANGAN

Dgnl. Jnsd.
Kty. Pns

NO	REVISI	PANAH		
		R1	R2	R3

Catatan



Mesra
NIPOLAN KOPERASI LEJAK MANDIRI DAN PERKULIAHAN KETEK PONTIANAK
DINAS KOPERASI, USAHA KURUS DAN PEDAGANGAN
PONTIANAK

Meratifikasi
PEMBANTU MANAJEMEN (PMBM)
SUDARNO SURMANTO, S.P., M.P.
M.P. PERDAGANGAN

SIKSEKUTUW GAMBAR
TIARA PILAR KREASI, PT
Jalan ...
TEL: ...

TEK. PERENCANAAN
ARHIT. LOUISA MULYAWATI, S.P.
STRUKTUR. NURHAMZAH, S.T.
MSE. ISMAHIL ZULM, S.T.

Dgnl. / Project
KOPERASI LEJAK MANDIRI DAN PERKULIAHAN KETEK PONTIANAK

Nama Gambar
DENAH LOS (LAPAK)

Skala	No. Gambar	No. Proyek
1:30		A.36

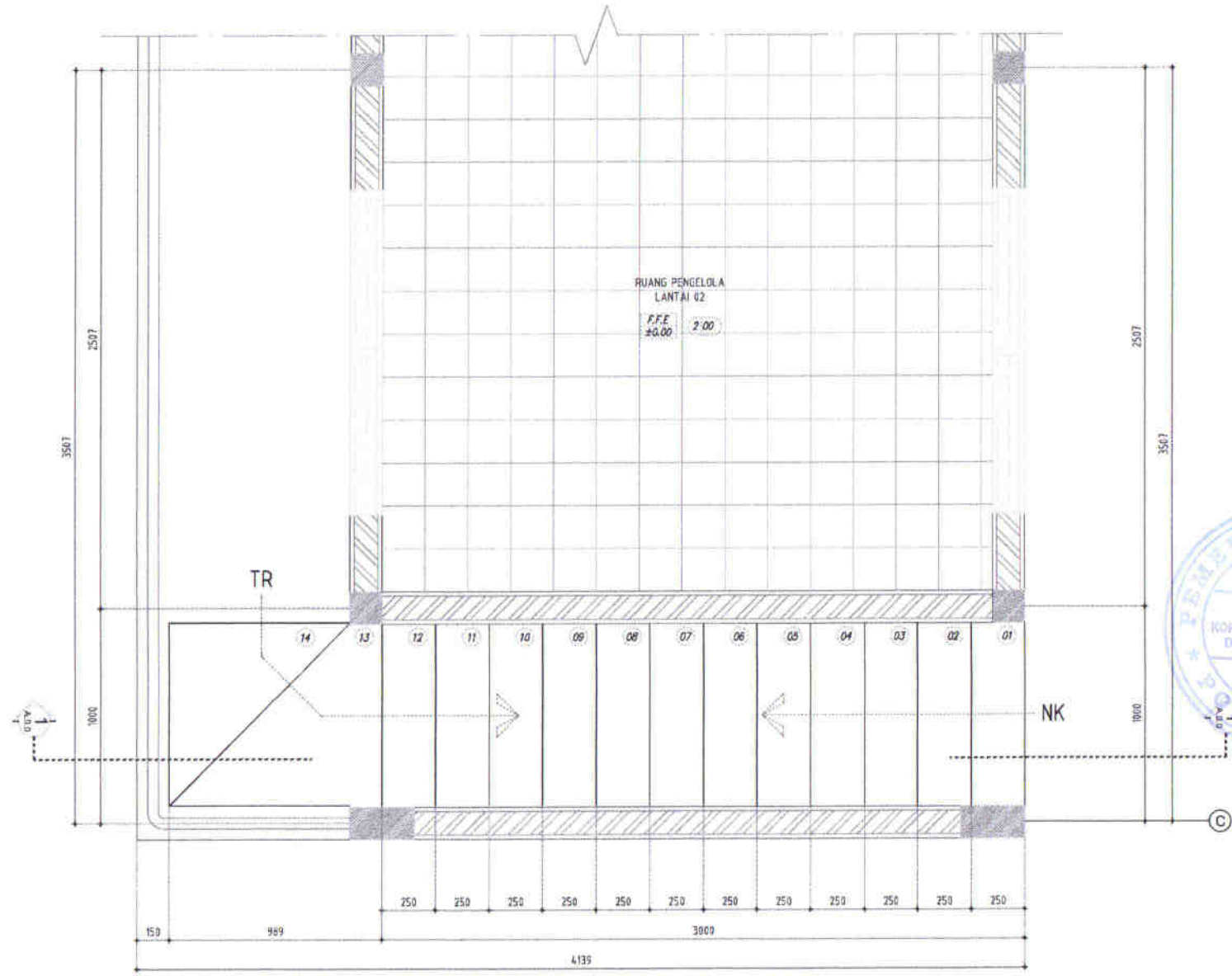

DENAH TANGGA
SKALA 1:20

KETERANGAN

Denah Lantai
Key Plan

NO	REVISI	PAPU		
		R1	R2	R3

Catatan



Mengetujui
REPUBLIK INDONESIA, DEPARTEMEN PERDAGANGAN
DITTA PARTAMANE
[Signature]
DINAS KOPERASI, USAHA
DAN PERDAGANGAN

Mengesahkan
PELAKSANAAN PERENCANAAN
[Signature]
DINAS KOPERASI, USAHA
DAN PERDAGANGAN

KONSULTAN GAMBAR
TIARA PILAR ARSINI, PT
Jl. ...
TIN PERUBAH

ARHITEK : LINDA WULANWAL ST MT

STRUKTUR : RAHMATUL FAZ ST

KEE : BAHAM ZALIM ST

Proyek
...
...
...

Revisi

No.	No. Gambar	No. Proyek

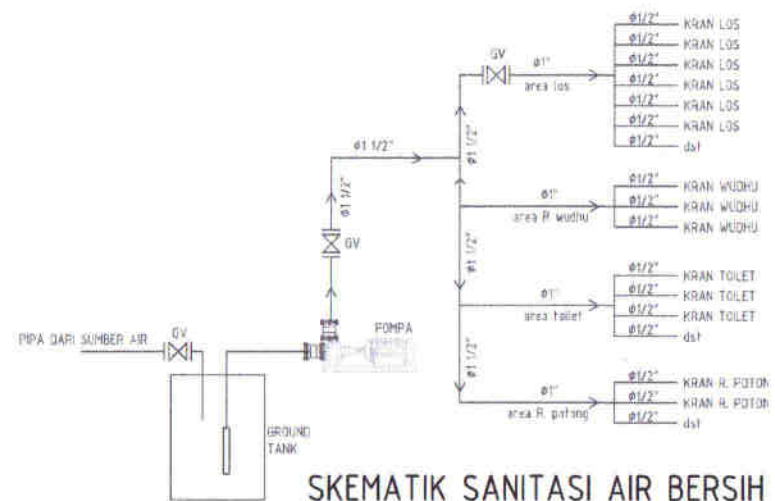
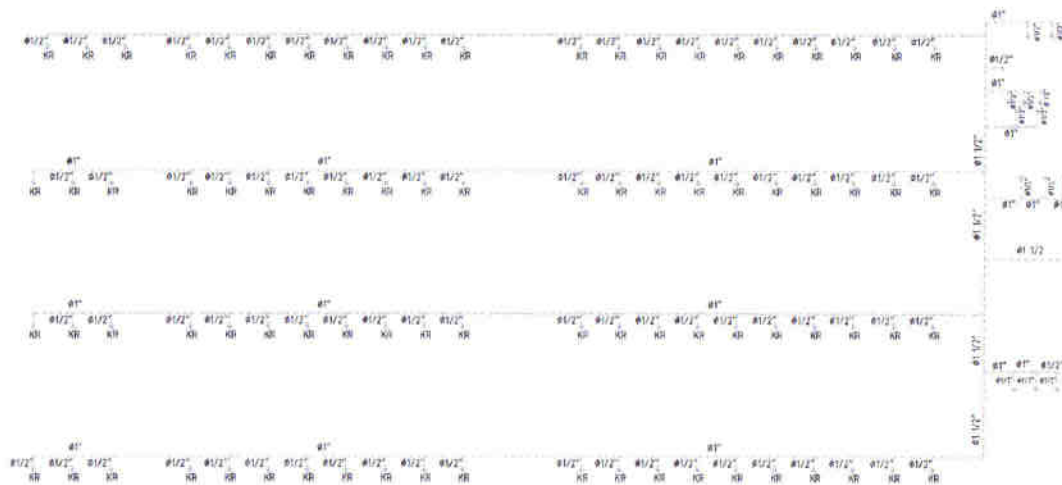

SKEMATIK SANITASI AIR BERSIH

KETERANGAN

Denah: Denah Key Plan

NO	REVISI	PARAF		
		RI	R2	R3

Legenda:
 KR : KRAN AIR
 WS : WASTAFEL
 FD : FLOOR DRAIN
 GV : GATE VALVE



Mengarahkan:
 KEPALA DINAS PERENCANAAN, USAHA BANGUN DAN PEMERIKSAAN
 (DINAS PERENCANAAN)

Mengarahkan:
 PELAKSANA PEMBAKUAN KEMENTERIAN PERENCANAAN

MONSIEUR GAMBAR:
TIARA PILAR KREASI, PT
 (Logo of Tiara Pilar Kreasi, PT)

TEN TERIMA:
 MENTERI: GUSRIAN HAROH, ST, MT
 STRUKTUR: MURNI RAHMAZUL, ST
 MEE: BHOVIN ALAM, ST

Project:
 (Project name and details)

Nama Gambar:
DENAH SANITASI AIR BERSIH

Skala	No. Gambar	No. Proyek
1:200		PL-01

DENAH SANITASI AIR BERSIH

SKALA 1:200

KETERANGAN

Daerah Muncul Key Plan

NO	REVISI	PARUF		
		RI	R2	R3

Catatan
 KR : KRAN AIR
 WS : WASTAFEL
 FD : FLOORRAIN



Meresahkan
 HOSPITAL DAN PERUSAHAAN USAHA BERSAMA SAMA PERUSAHAAN
 KOTA KUPATANGKAS
 KOPERASI DAN USAHA BERSAMA SAMA
 KOTA KUPATANGKAS

Meresahkan
 PERUSAHAAN PERUSAHAAN PERUSAHAAN
 HANIKO BUNYI TEKNIK DAN
 KONSULTAN GABUNG

KONSULTAN GABUNG
TIARA PILAR KREASI, PT
 Perencanaan & Desain Arsitektur & Interior
 Gedung Korpri Lt. 5
 Jalan Sisinga, 10119 Jakarta

TIM TEKNIK
 MESTRY LOUVE WJ. HANIKO, ST. MT
 ESTILUTY MAHARUFAZ ST
 IREK BERNYI, D.L.R. ST

Desain Project
 PERUSAHAAN PERUSAHAAN PERUSAHAAN
 KOTA KUPATANGKAS

Daerah Gambar
 DETAIL SANITASI AIR BEKAS AREA TOILET DAN WUDHU

Skala	No. Gambar	No. Proses
1:40		PL 04

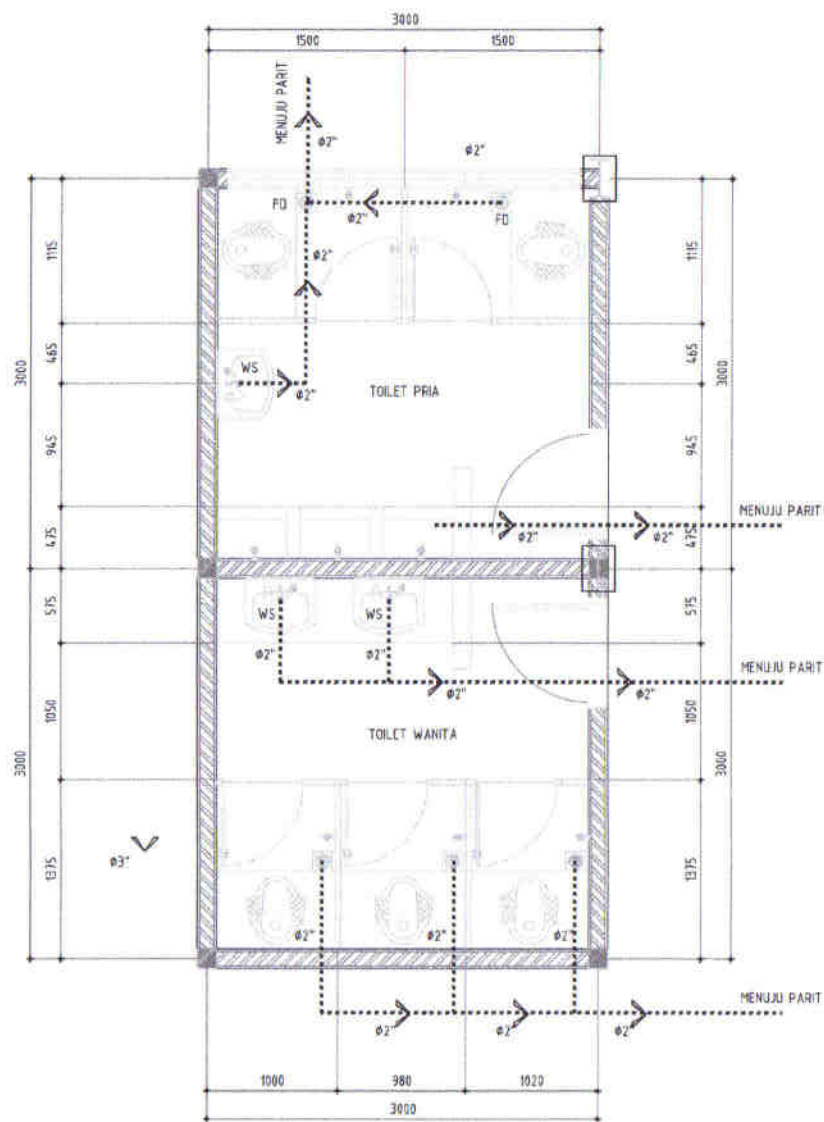

DETAIL INSTALASI AIR BEKAS TOILET
 SKALA 1:40

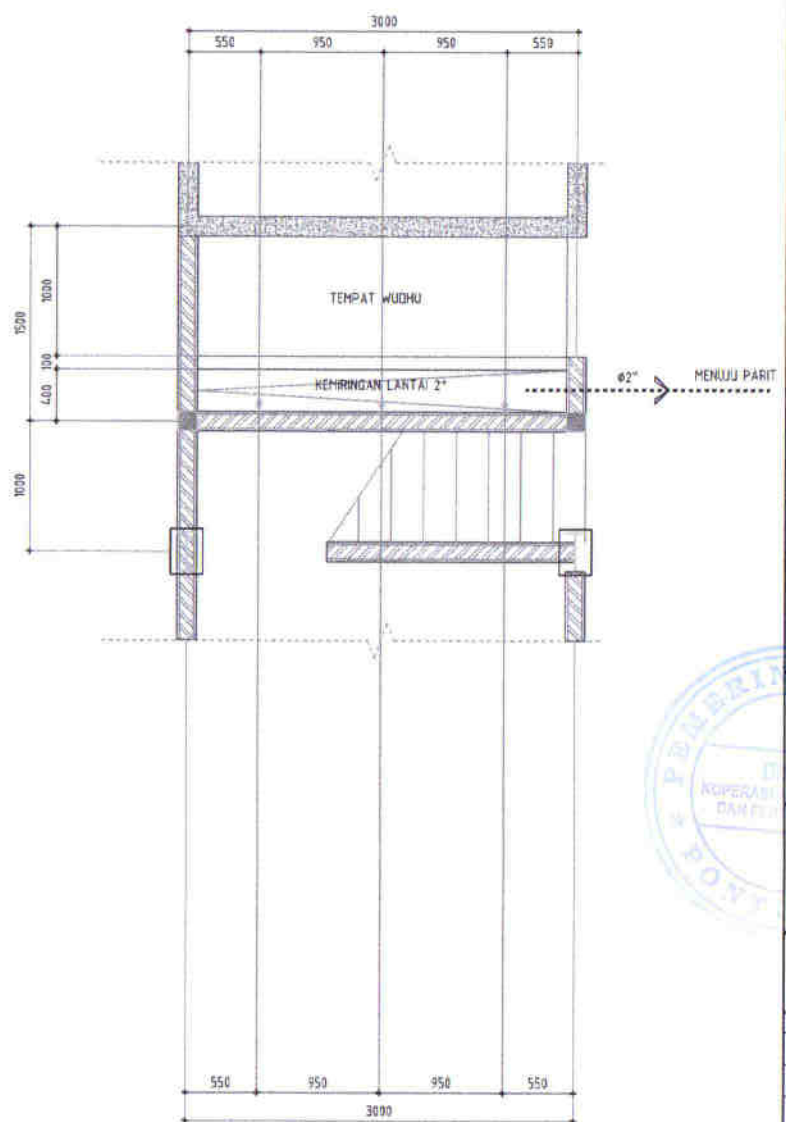

DETAIL INSTALASI AIR BEKAS T.WUDHU
 SKALA 1:40



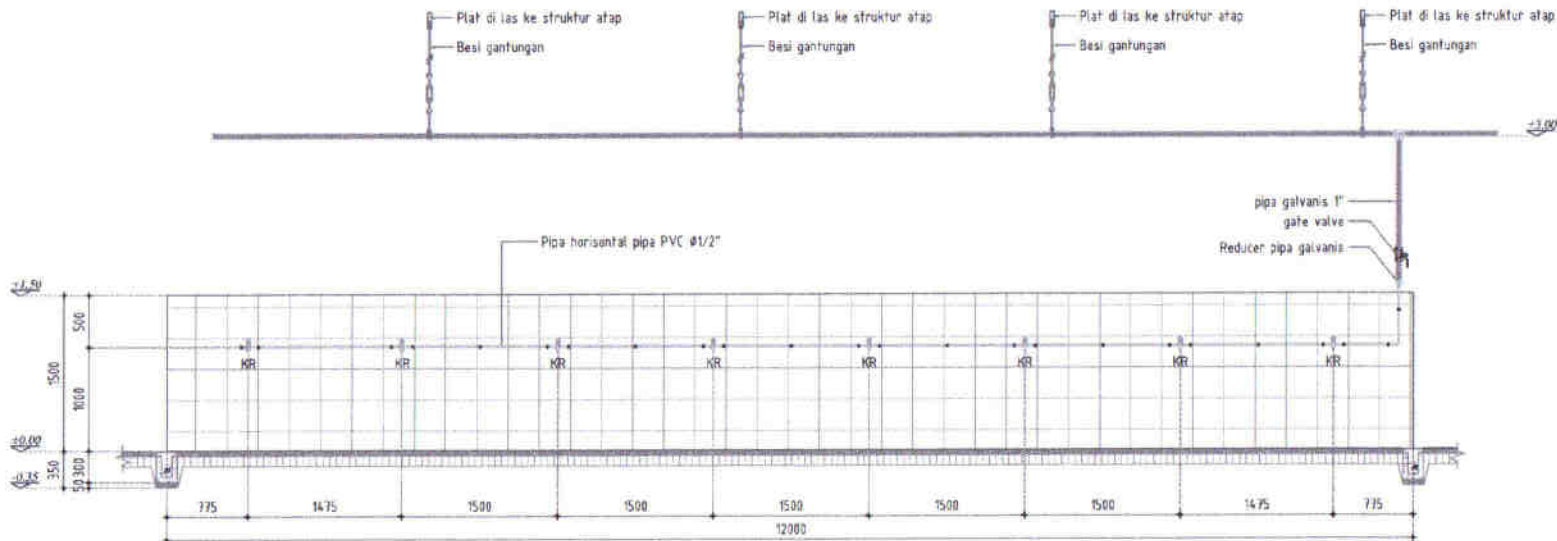

DETAIL INSTALASI AIR BERSIH LOS

SKALA 1:40

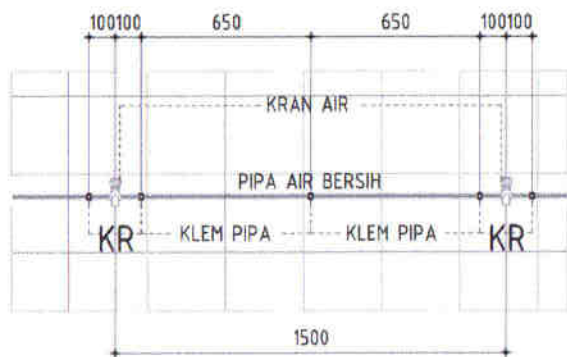

DETAIL KLEM

SKALA 1:20

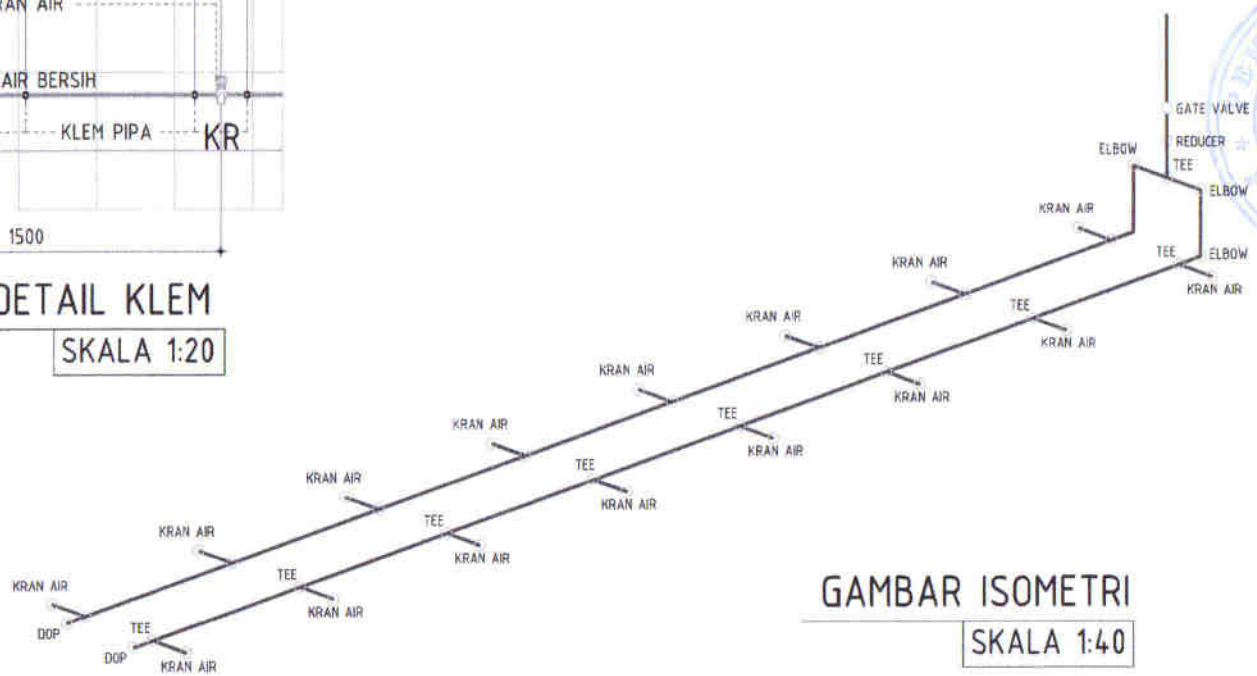

GAMBAR ISOMETRI

SKALA 1:40

KETERANGAN

Detail Instalasi
Key Plan

NO	REVISI	PARAF		
		R1	R2	R3

Legenda

- KR : KRAN AIR
- WS : WASTAFEL
- FD : FLOOR DRAIN
- GV : GATE VALVE

Logo Client



Mengesahul

KETUA DINAS PERDAGANGAN (SMAK) BINA PERDAGANGAN
BINA PERDAGANGAN
[Signature]
DINAS PERDAGANGAN
KOPERASI, USAHAWA DAN PERDAGANGAN

Mengesahul

PEJABAT PEMERINTAH KEMENTERIAN PERDAGANGAN
[Signature]
DINAS PERDAGANGAN
KOPERASI, USAHAWA DAN PERDAGANGAN

KONDISI GABUNG

PT. TIARA PIJAR KREASI, PT.
KEMENTERIAN PERDAGANGAN REPUBLIK INDONESIA

TEK. PERENCANAAN

ANOTASI: LUSSE VILLAGE PT. NET
STRUKTUR: MURNIANDYAN PT.
ME: GRAND ZOLA PT.

Project

Detail Instalasi Air Bersih Area LOS

Detail Gambar

DETAIL SANITASI AIR BERSIH AREA LOS

Shed	No. Gambar	No. Proyek
150		PL.03

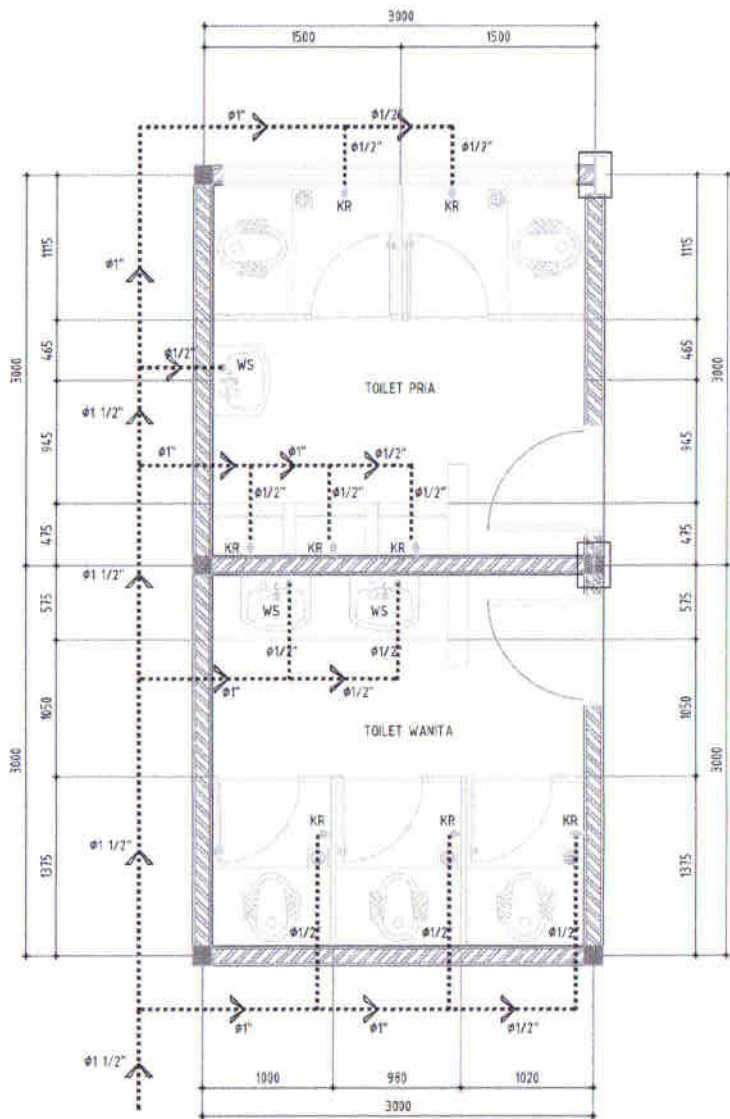

DETAIL INSTALASI AIR BERSIH TOILET
SKALA 1:40

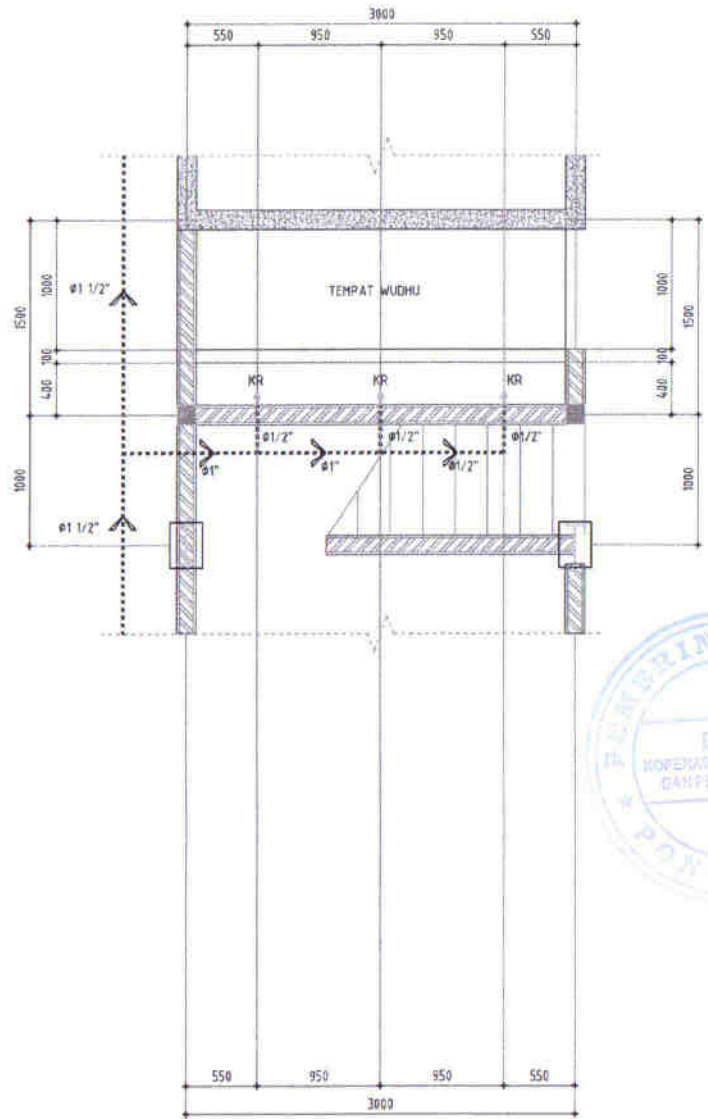

DETAIL INSTALASI AIR BERSIH T.WUDHU
SKALA 1:40

KETERANGAN

Denah Kumpul
Key Plan

NO	REVISI	PARAF		
		R1	R2	R3

Catatan:
KR : KRAN AIR
WS : WASTAFEL



Mengetahui
REPLIKA TRADE SERVICES, MANAJEMEN DAN PERENCANAAN
GIZIA PUTRIANNA
[Signature]
KORPORASI
KORPORASI

Mengetahui
PILLET TEKNIK (INDONESIA) PT
[Signature]
KORPORASI

KONSULTAN GAMBAR
TIARA PILAR KREASI, PT
Manajemen & Engineering Consultant
Jl. Raya ...

TIM TEKNIS
KORPORASI
KORPORASI
KORPORASI

Project
KORPORASI
KORPORASI

Nama Gambar
KORPORASI
KORPORASI

Skala	No. Gambar	No. Proyek
1:40		PL.01

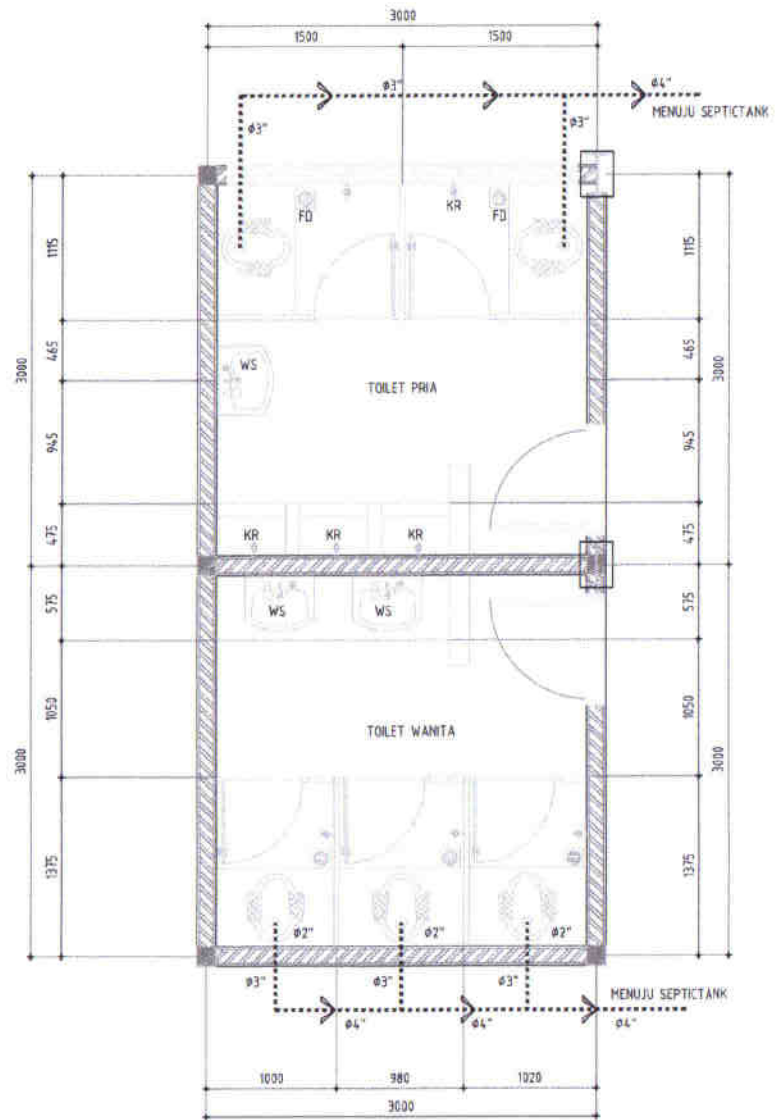

DETAIL INSTALASI AIR KOTOR TOILET

SKALA 1:40

KETERANGAN

Detail Kunci
Key Plan

NO	REVISI	PAREL		
		R1	R2	R3

Condition

KR : KRAN AIR
WS : WASTAFEL
FD : FLOOR DRAIN

Klien
Client



Mengarahkan
Directing

KONSTRUKSI PERENCANAAN, PEMERIKSAAN DAN PENGAWASAN
KONSTRUKSI

[Signature]
ARMO S.P. ST.
PENGAWAS

Mengontrol
Controlling

PERMITTING (PERMITTING)

[Signature]
RACHMAD SUPRIATNO ST. ST.
PENGAWAS

KONSULTAN GAMBAR
Drawing Consultant

TIARA PILAR KREASI, PT
Management & Engineering Firm
Jl. Raya ...

TEKNIKUS

ARQUITEK LOUWIJANINGSIH ST. ST.

STRUKTUR MUHAMMAD FAZ ST.

MSE SIPRIAN BILUK ST.

Detail
Project

Nama Gambar
Drawing Name

SANTIASI AIR KOTOR

Skala	No. Gambar	No. Proyek
1:40		PL-06

KETERANGAN

Denah Kamar
Bey Plan

AREA DETAIL

NO	REVISI	PANSIF		
		W1	R2	R3

- Catatan:
- CL : CLOSET
 - FD : FLOOR DRAIN
 - WS : WASTAFEL
 - UR : URINDOR

Pilih
Client



Meresahkan

KEPALA DINAS KEPASTIHAN UJIAN KEMERDIAAN PERDAGANGAN
KOTA POMBAKKA

[Signature]
SUDARNO SUDARNO, S.T., M.M.
NIP. 195901011980001001

Meresahkan

PEMINTA BUKU/LENGKAPAN POKOK

[Signature]
SUDARNO SUDARNO, S.T., M.M.
NIP. 195901011980001001

KONTRAKTOR

TIARA PILAR BUREASI, PT
Jl. ...
No. ...

TEK. TRUSMI

ARITIK : LUVIE WANDANA, ST. MT. *[Signature]*

STRUKTUR : MUHAMMAD FAZ, ST. *[Signature]*

MEL : SIPRAN, DUK, ST. *[Signature]*

Proyek / Project

...
...
...
...
...
...

Nama Gambar

DETAIL DENAH TOILET

Skala	No. Gambar	No. Panoah
1:30		A.28

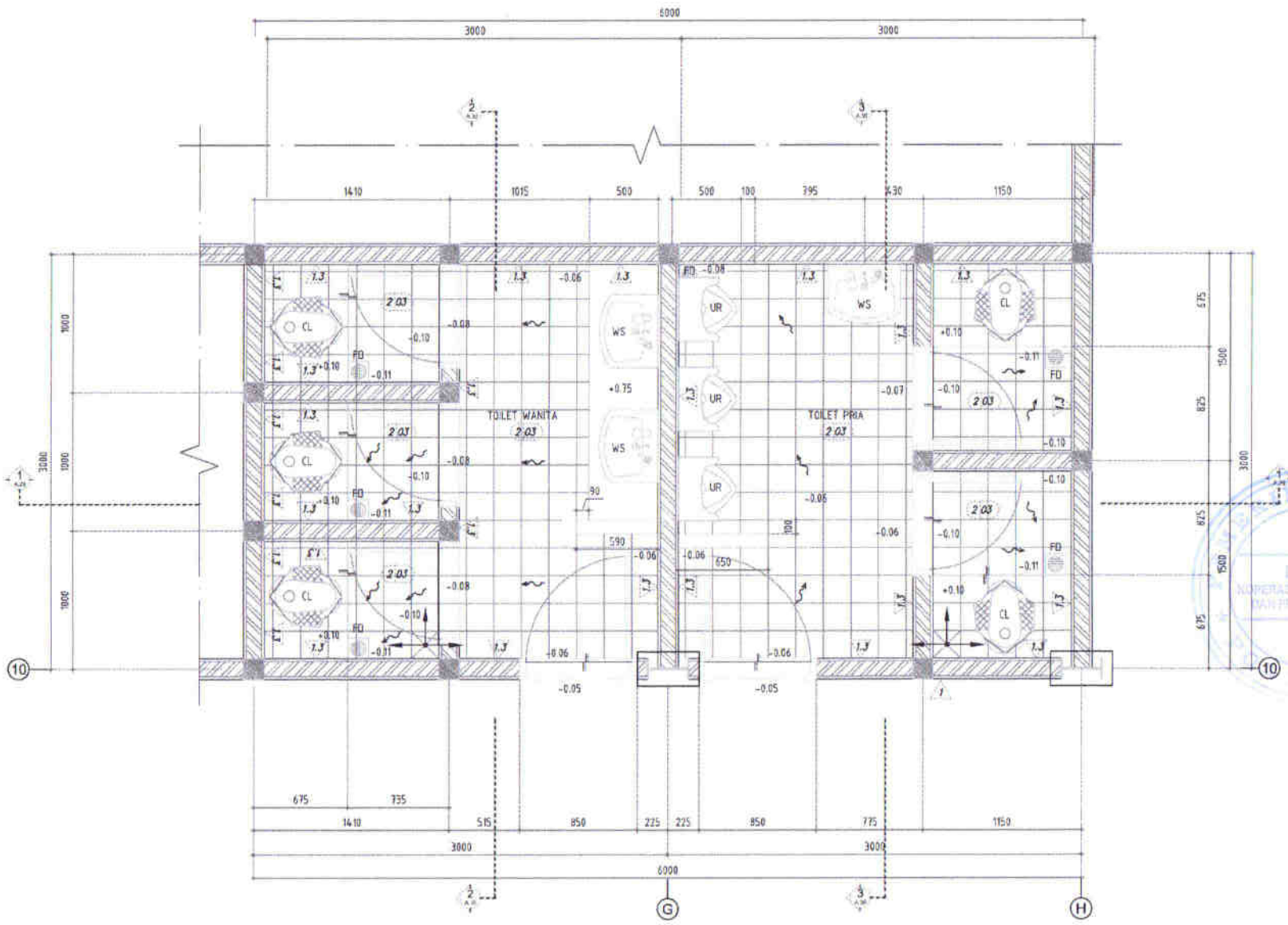

DENAH KAMAR MANDI
SKALA 1:30

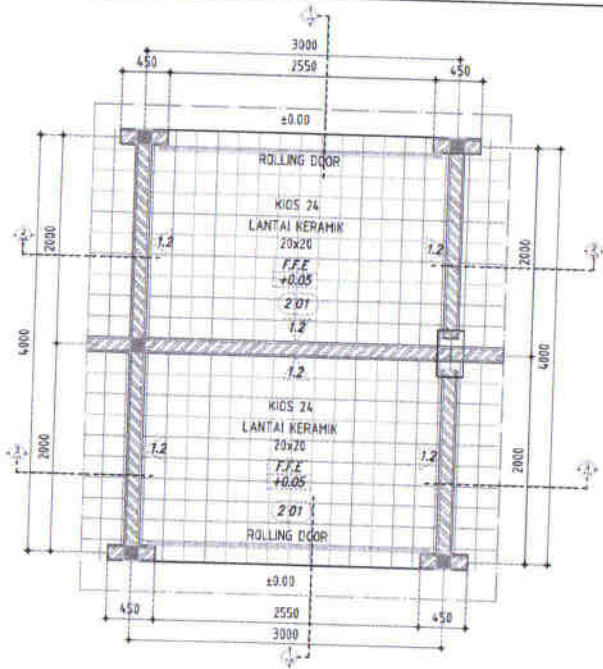

DENAH KIOS 24&11
SKALA 1:50

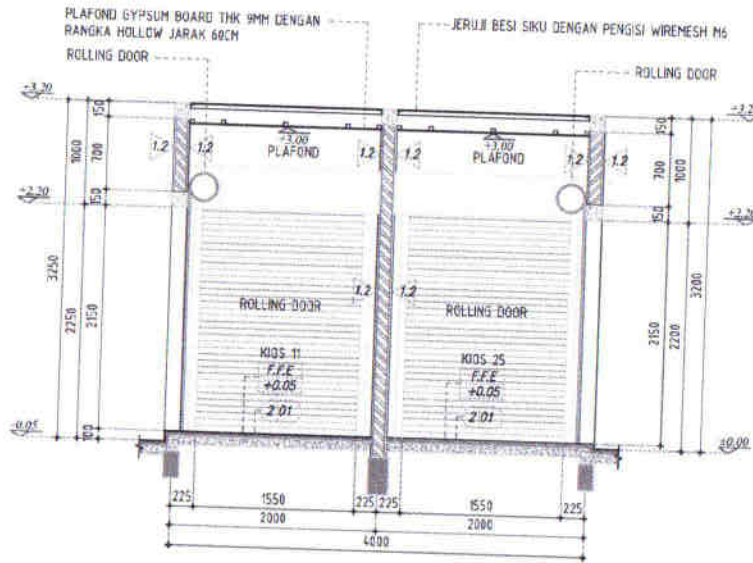

POTONGAN 1
SKALA 1:50

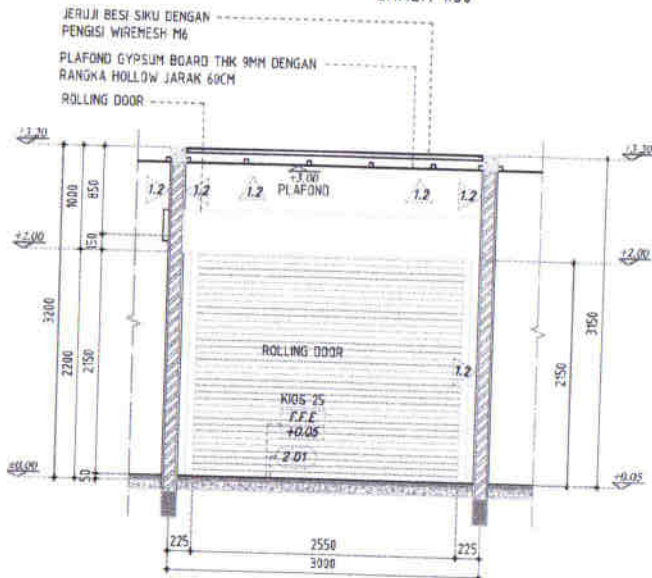

POTONGAN 2
SKALA 1:50

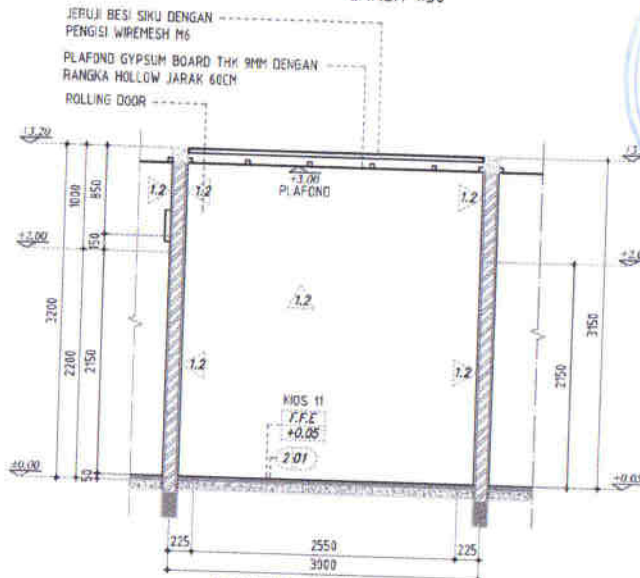

POTONGAN 3
SKALA 1:50

KETERANGAN

Detail Kios
Key Plan

NO	NAMA	PARAF		
		RI	PI	RI

Catatan:

Klien:



Manajemen:

KEPALA DINAS KOPERASI, USAHA MIKRO DAN PERDAGANGAN
KOTA PONTIANARA

[Signature]
DINAS KOPERASI, USAHA MIKRO DAN PERDAGANGAN
KOTA PONTIANARA

Manajemen:

PEKERJA PEMBUKTI POKOK BUNYAN

[Signature]
DINAS KOPERASI, USAHA MIKRO DAN PERDAGANGAN
KOTA PONTIANARA

KONSTRUKSI GIMBAR:

TIARA PILAR KREASI, PT
Management & Engineering Consultant

TEKNIK

ARHITEK: LUCY ESTER WULANING ST MT

STRUKTUR: NIRMALINDO FAIZ ST

MES: SHAWAN ZULHADI ST

Project:

PROJEK: RENCANA TERAJUK KAWASAN PERDAGANGAN
KOTA PONTIANARA

Nomor Gambar:

DETAIL KIOS 24&12

Skala:	No. Gambar	No. Proyek
1:50		A-35

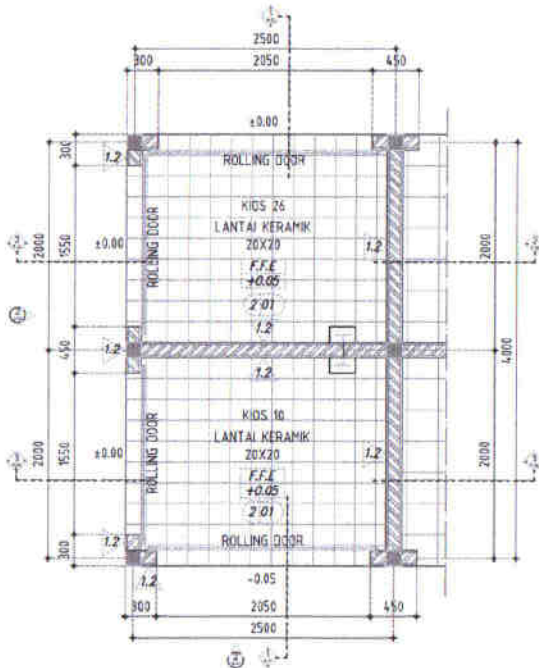

DENAH KIOS 26&10

SKALA 1:50

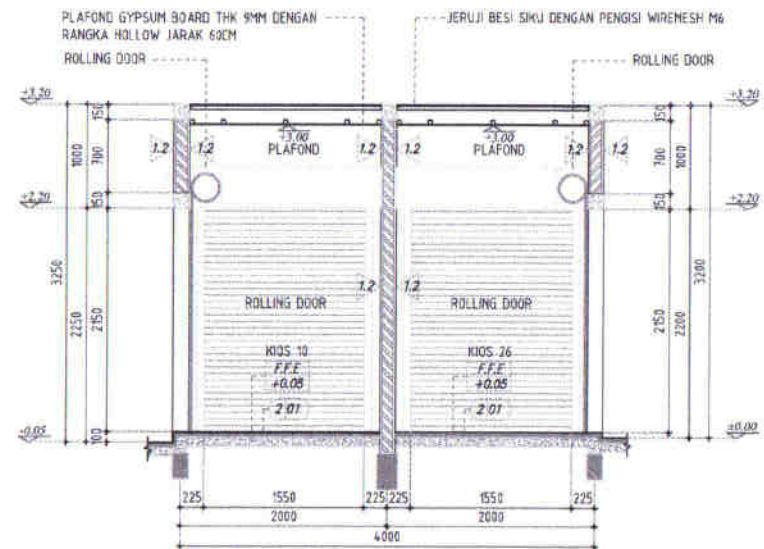

POTONGAN 1

SKALA 1:50

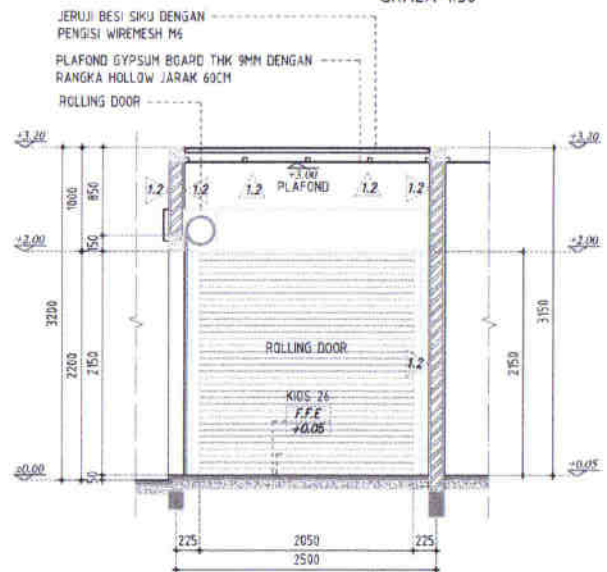

POTONGAN 2

SKALA 1:50

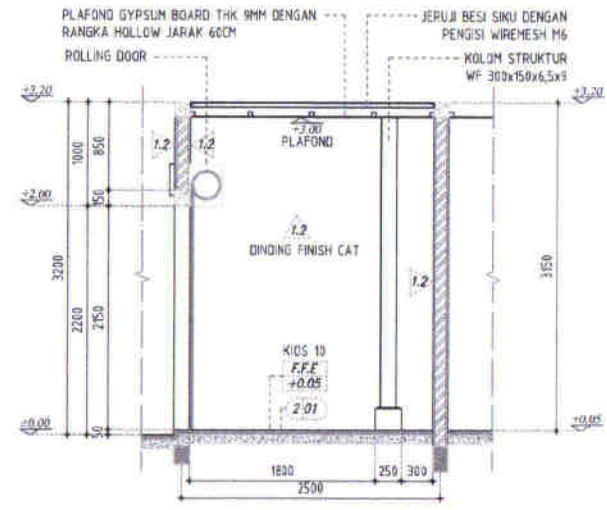

POTONGAN 3

SKALA 1:50

KETERANGAN

Demah Maud
My Plan

NO	REVISI	PARAF		
		R1	R2	R3

AREA DETAIL

Catatan



Mengesahul
KEPALA DINAS KOPERASI, USAHA MUDA DAN PERDAGANGAN
KOTA PONTIANAK
[Signature]
ARAFAT S.P. M.S.
0812222222222



Mengetahui
TEKNIK PERENCANAAN KAWASAN PERKOTAAN
[Signature]
DINAS PERENCANAAN KAWASAN PERKOTAAN
KOTA PONTIANAK

KONSTRUKSI CAKUPAN
TIARA PILAR KREASI, PT
Jl. Raya P. 11, Pontianak, Kalimantan Barat
Telp. (0561) 8222222

TEKNIK
ARBITER: LOUIS WILHELMUS ST. ST.
STRUKTUR: MAHAMUD AZEIZ
MEK: GWAN ZULU ST.

Project
Project

Jumlah Gambar
DETAIL KIOS 26&10

Skala	No. Gambar	No. Proyek
1:50		A.32

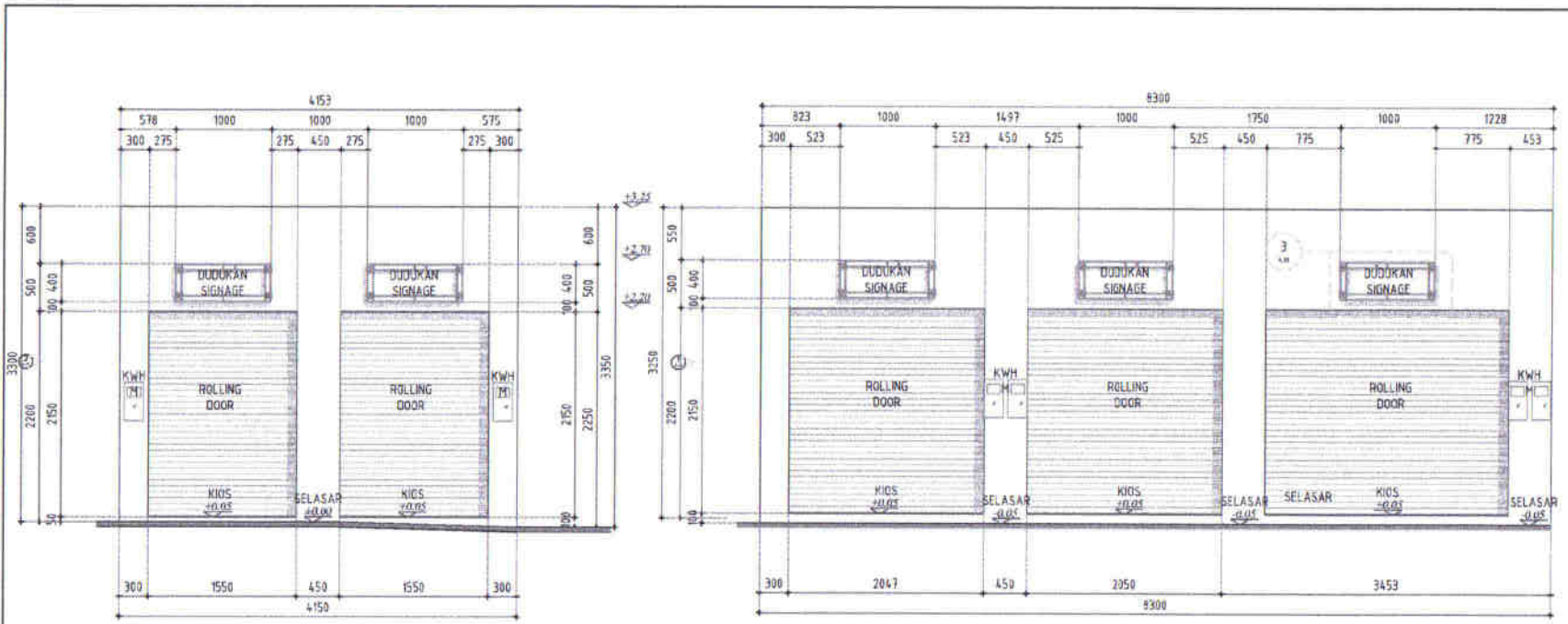

TAMPAK A
SKALA 1:50

TAMPAK B
SKALA 1:50

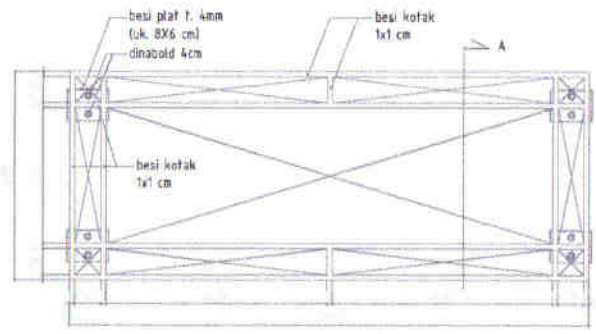

TAMPAK DEPAN

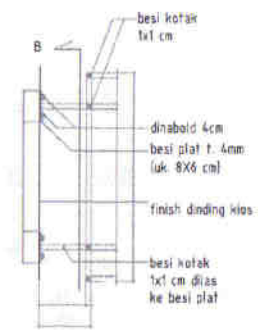

POTONGAN -A

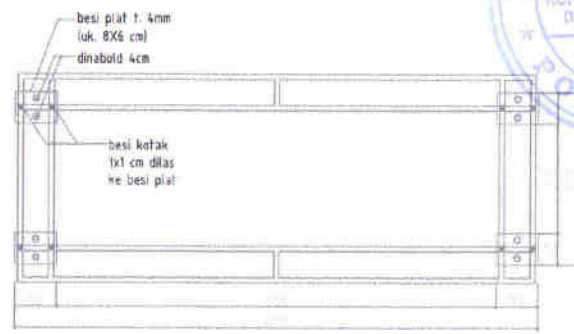

POTONGAN -B

DETAIL 1 (PAPAN NAMA KIOS)
SKALA 1:10

KETERANGAN

Detail Kios
Key Plan

NO	REVISI	TARICAH		
		R1	R2	R3

Catatan



Mengetahui
 KEPALA DINAS KOPERASI, USAHA BERSAMA DAN PERDAGANGAN
 AGUS PERMANUNG
 (Signature)
 Mengetahui
 REJASAT PERENCANAAN KAWASAN PERDAGANGAN
 (Signature)
 KIRWAN SUPRIATNO, S.T., M.T.
 (Signature)

JAWABAN GABUNG
TIARA PILAR KREASI, PT
 (Logo and company name)

TIM TEKNIK
 KOTAK: LAUSE BILAKAWAL, ST., AT
 STRUKTUR: MUHAMMAD FAUZI ST
 MEB: WAHANI ZULHI, ST

Proyek
 (Project name and details)

Daftar Gambar

Skala	No. Gambar	No. Proyek
1:50		A 33

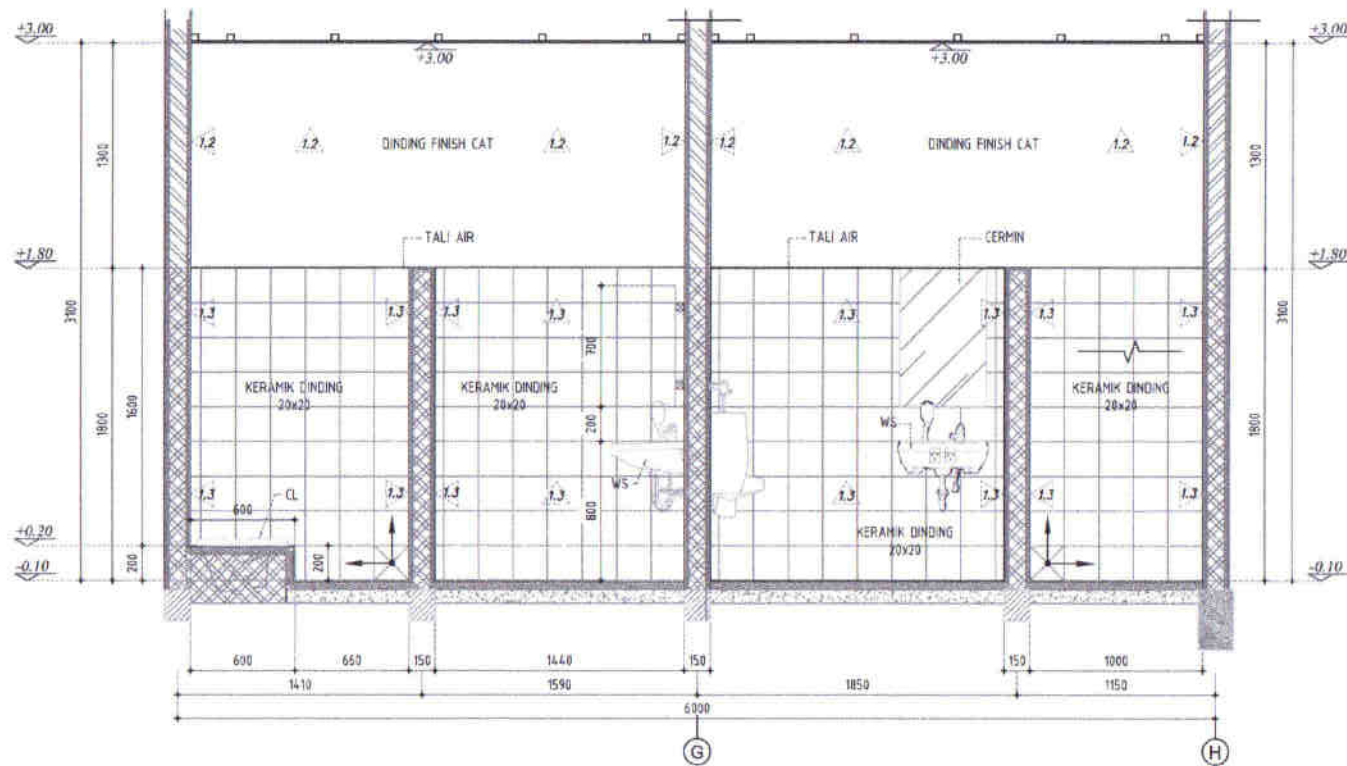

POTONGAN 1-1
SKALA 1:30

KETERANGAN

Dimensi, Ketinggian,
Key Plan

NO	REVISI	PARAF		
		RI	RD	R3

Catatan:

- CL : CLOSET
- FD : FLOOR DRAIN
- WS : WASTAFEL
- UR : URINDIR

Logo Client



Merespon:

KERJASAMA KEPERAWATAN DAN PERAWATAN POKOK
KOTA PONTIANAK

[Signature]
ARIPRIYANTO, S.T.

Merespon:

PEMBANTU HUKUM PONTIANAK

[Signature]
SUCIYATI, S.H., M.H.

KONSULTAN CAMBUT

TIARA PILAR KREASI, PT
Konsultansi & Engineering & Services
Jl. ...

TEKNIK

DESAIN	LUCIE MALINDA, ST, IT	<i>[Signature]</i>
STRUKTUR	MUHAMMAD AZIZ	<i>[Signature]</i>
MEK	IBRAHIM ZULH, ST	<i>[Signature]</i>

Project
KORPORASI KEPERAWATAN DAN PERAWATAN POKOK
KOTA PONTIANAK

Nama Gambar
DETAIL TOILET POTONGAN 1

Skala	No. Gambar	No. Proyek
1:30		A.29

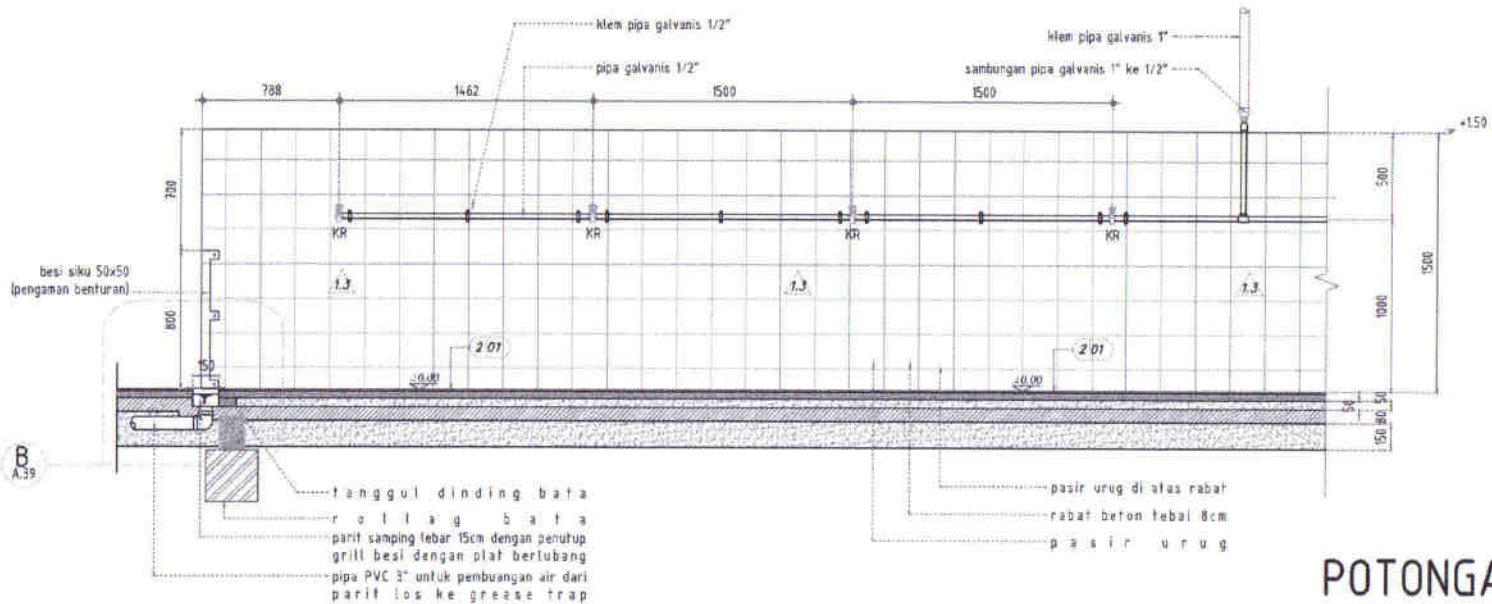

POTONGAN 1
SKALA 1:30

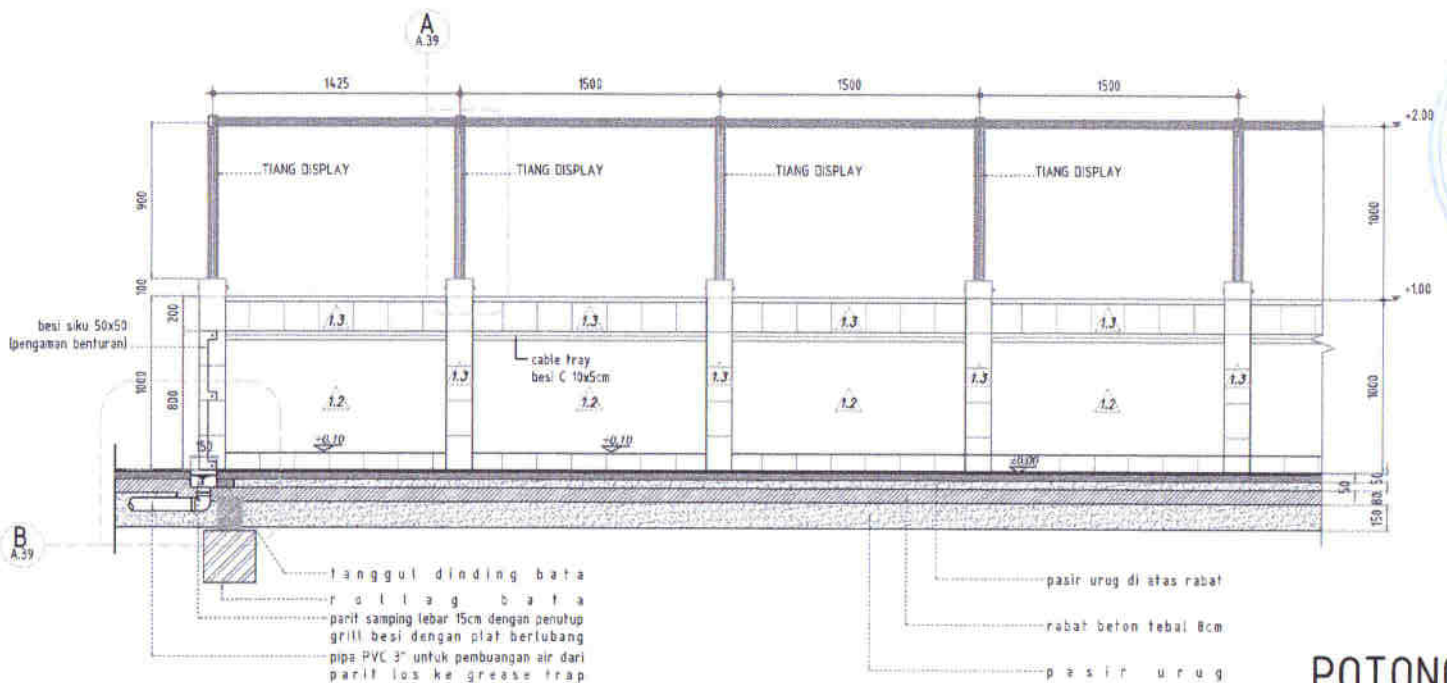

POTONGAN 2
SKALA 1:30

KETERANGAN

Dimensi
Ruang
Rencana

NO	REVISI	PARAF		
		RI	RE	RS

Catatan



Membuat
KORPORASI USAHA BANGUNAN PENGALANGAN
KETA PONTIANAK
XMAH
KORPORASI USAHA BANGUNAN PENGALANGAN
KETA PONTIANAK

Membuat
PELAKSANAAN PERENCANAAN
[Signature]
KORPORASI USAHA BANGUNAN PENGALANGAN
KETA PONTIANAK

KONSTRUKSI CIVIL
TIARA PILAR KREASI, PT
Perencanaan & Pengawasan Konstruksi
Jl. Raya Garuda No. 10
Pontianak, Kalimantan Barat

TEKNIK
HOSTER LOUIS WILHON, ST, MT
STRUKTUR MAHENDRA DT
MEI BRAHMAN, ST

Project
KORPORASI USAHA BANGUNAN PENGALANGAN
KETA PONTIANAK

Nama Gambar
DETAL TAMPAK LOS(LAPAK)

Skala	No. Gambar	No. Proyek
1:30		A.39

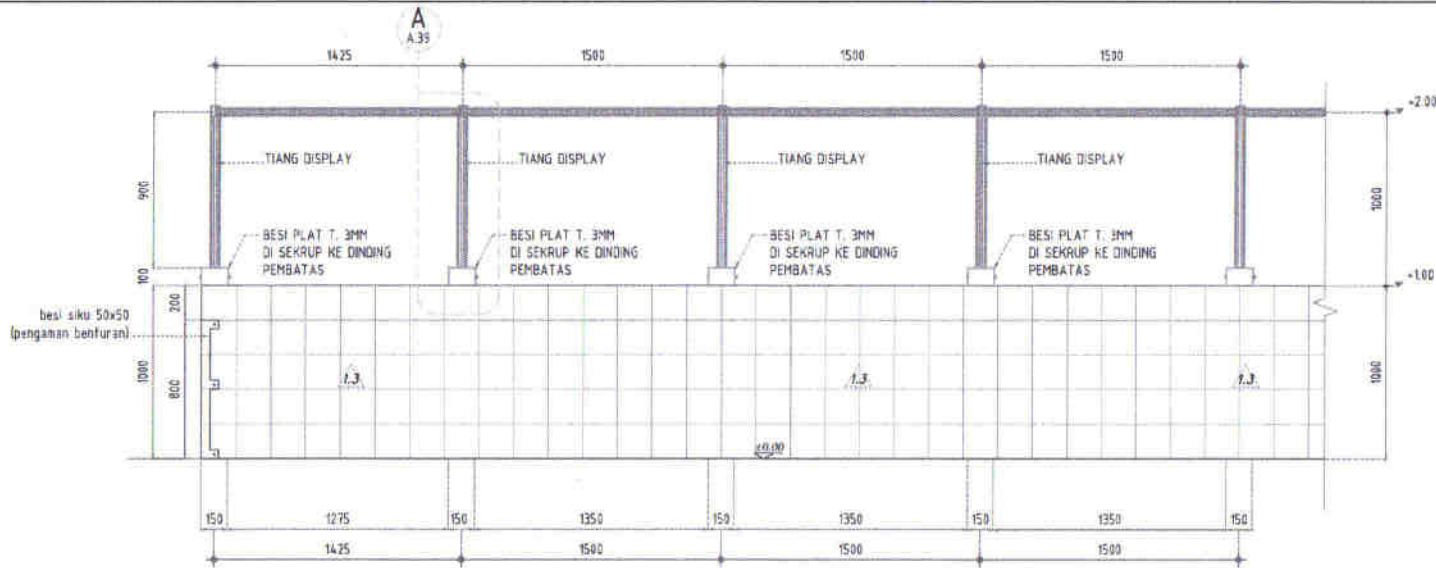

TAMPAK 1

SKALA 1:30

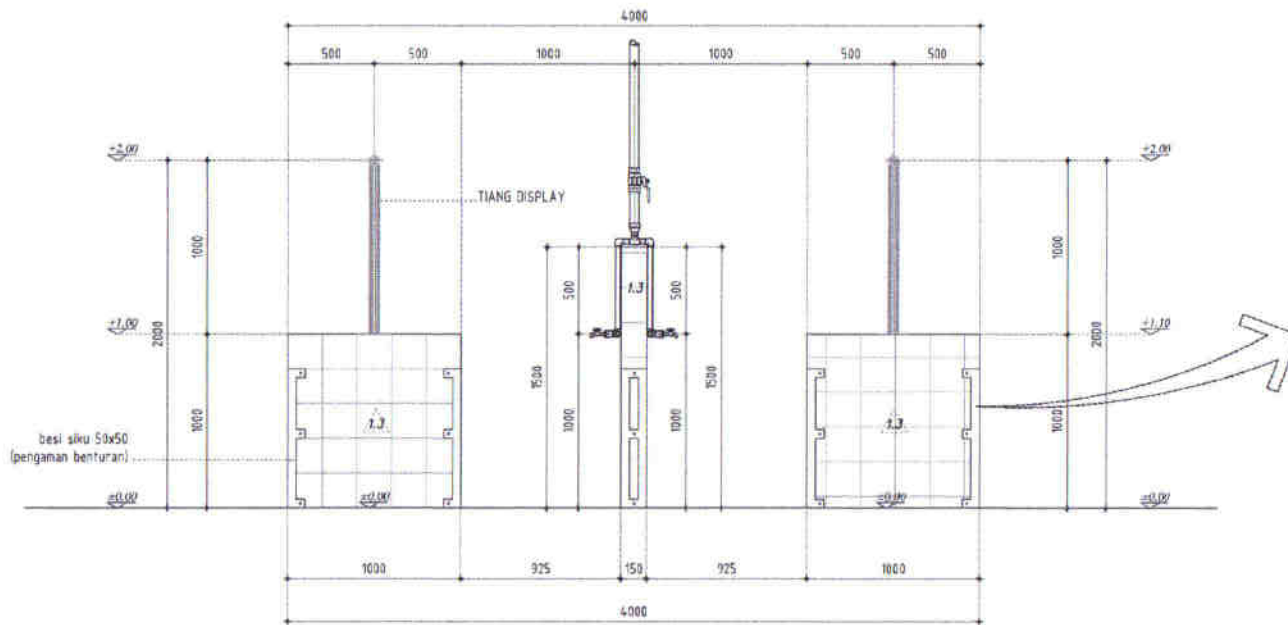

TAMPAK 2

SKALA 1:30



KETERANGAN

Dimensi, Jumlah, Key Plan

NO	REVISI	PARAF		
		RI	R2	R3

Catatan

Klien

 BEMEN TRILAKA PERDAGANGAN BERSAMA SAMA INDONESIA
 MINISTRY OF TRADE
 19 Melawai Road (Floor No. 3)
 Jakarta Pusat, 17111 Indonesia

Mengarahkan
 NORA LINDA KURNIAWATI, UJIAN MANDIRI DAN PENYUSUNAN
 AKTIF PAKAR/PAHA

 ARDHI PRATIWI
 ARDHI PRATIWI

Mengarahkan
 PELAKSANAAN KONSTRUKSI (PENGON)

 SAGUNG HARJOYO, ENR, SE, MS
 W. PONTIANAK

KONSTRUKSI CIKAMPUR

TIARA PILAR KREASI, PT
 Managemen & Pengembangan Konstruksi
 & Jasa Lainnya
 Jl. Raya Cempaka Putih No. 10
 Jakarta Pusat, 10110 Indonesia

TEKNIKER
 ARSITEK LOUISE WALINDA ST, MT
 DESAINER MUHAMMAD FAIZ ST
 ARI BRUNO ZUMAR ST
 Project
 Potongan dan Detail LOS

Skala Gambar

POTONGAN DAN DETAIL LOS

Skala	No. Gambar	No. Proyek
1:30		A.38

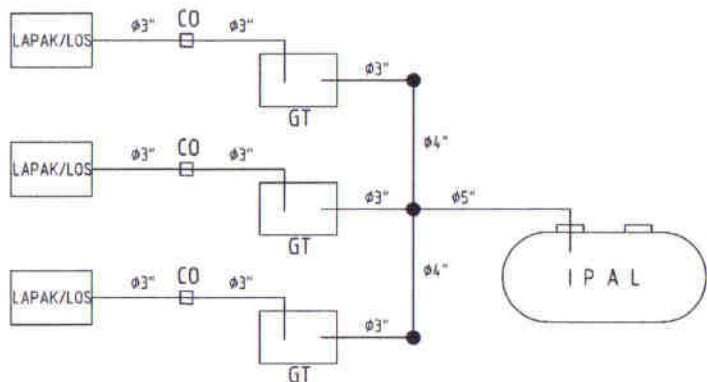
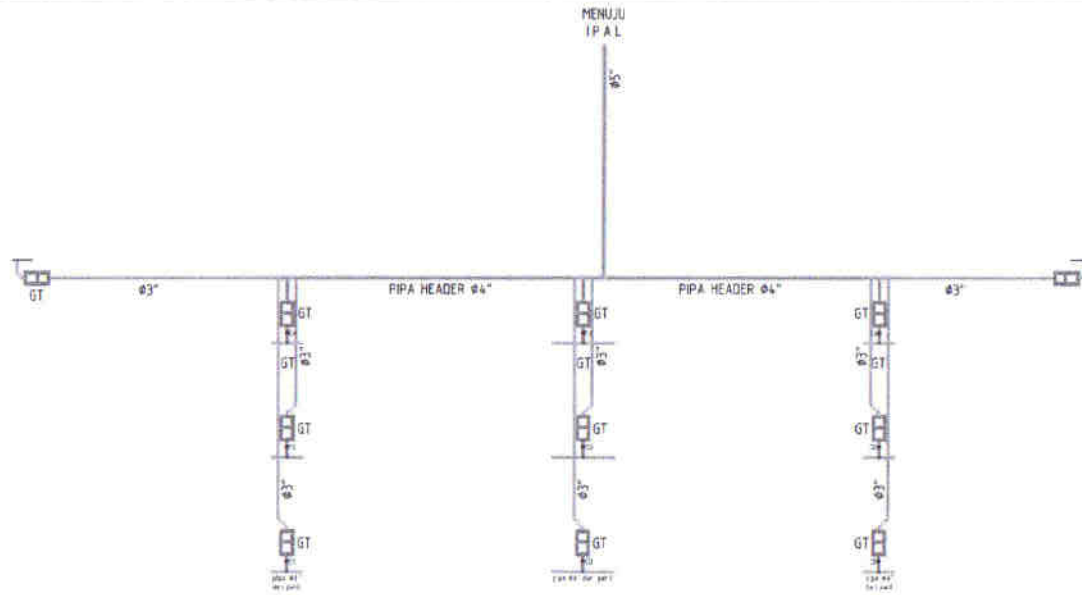

SKEMATIK DRAINASE AIR BEKAS

DENAH DRAINASE AIR BEKAS AREA LOS DAN PERLETAKAN GREASE TRAP
SKALA 1:250_XREF

KETERANGAN

Daftar Isi
Key Plan

NO	REVISI	PARAF		
		R1	R2	R3

Legenda
GT : GREASE TRAP
CO : CLEAN OUT

Logo
Clear



Mengesahkan

REPUBLIK INDONESIA, UJAH UMUM DAN PERINDUSTRIAN
KOTA PONTIANAK
[Signature]
DIREKTUR JENDERAL
UMUM DAN PERINDUSTRIAN

Mengesahkan

REKAMAT PERUMAH KOTA PONTIANAK
[Signature]
DIREKTUR PERUMAHAN KOTA PONTIANAK

KONSULTAN UMUM



TEKNIKIS

ARHITK: LOISE LULLANDI, ST, MT *[Signature]*

STRUKTUR: WIRAWAN FALIST *[Signature]*

MSE: @SAVITRIAH, ST *[Signature]*

Proyek
Project
Konsultasi dan Perencanaan
Perumahan, Kota Pontianak

Nama Gambar

DENAH DRAINASE AIR BEKAS AREA LOS DAN PERLETAKAN GREASE TRAP

Skala	No. Gambar	No. Proyek
1:250_XREF		PL-05

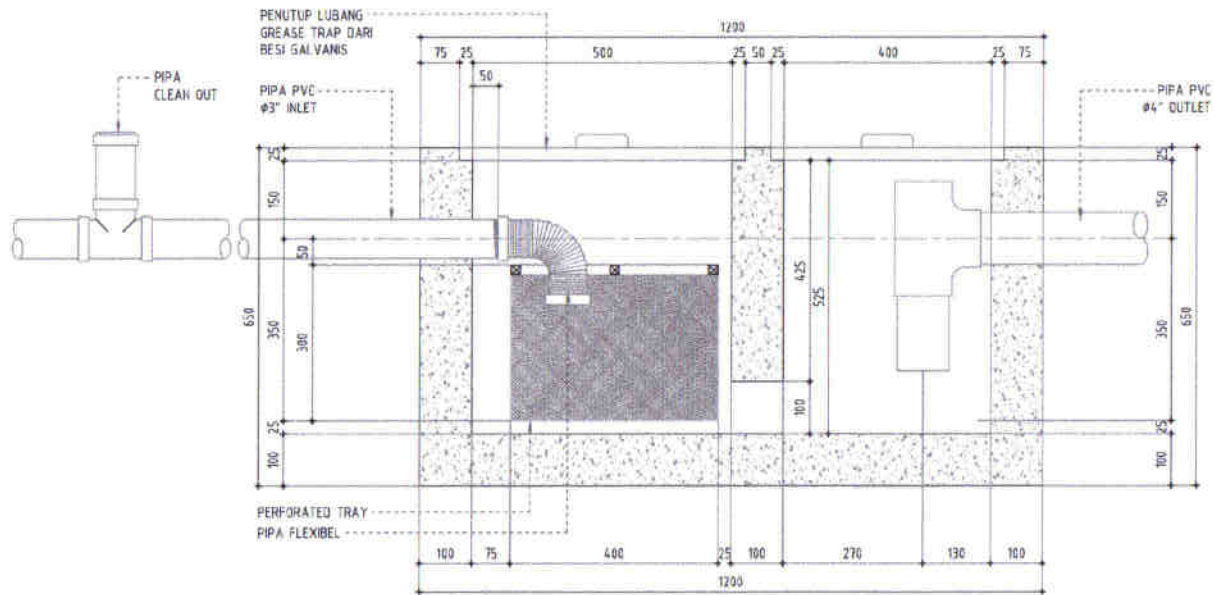

DETAIL POTONGAN GREASE TRAP
SKALA 1:10

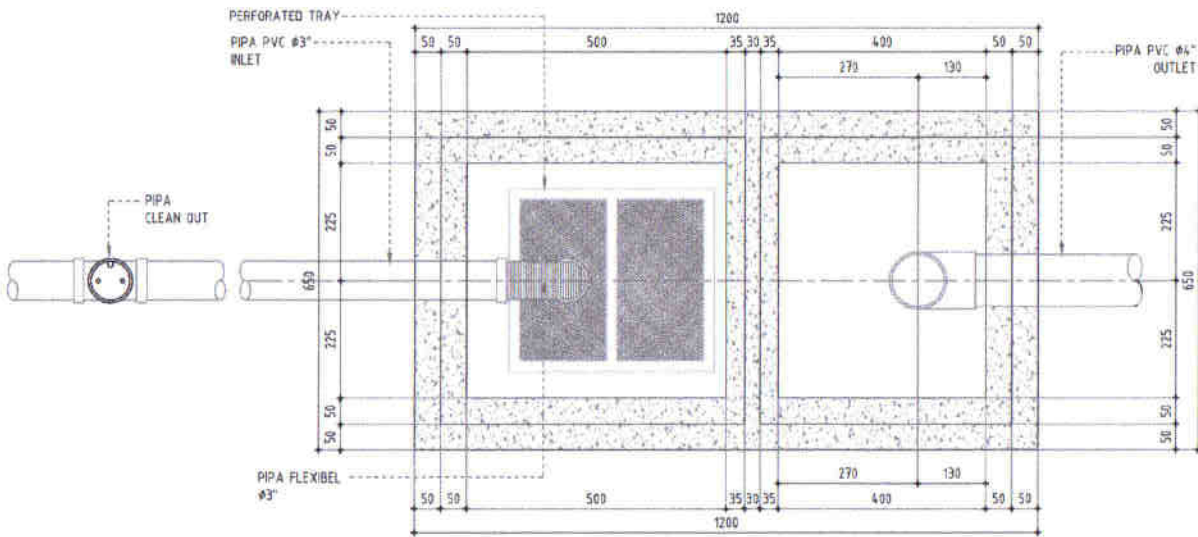

TAMPAK ATAS GREASE TRAP
SKALA 1:10

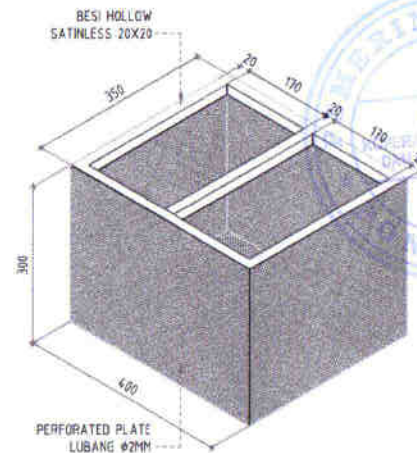

DETAIL SARINGAN GREASE TRAP
SKALA 1:10

KETERANGAN

Revisi Tabel
Rev. Plan

NO	REVISI	PARAF		
		IR	P2	R3

Coloris



Manajemen
KEPALA DINAS KOPERASI, USAHA MIKRO DAN PEREKONOMIAN KOTA FORDONGAI
YANI
KORPORASI
JURUSAN MANAJEMEN

Manajemen
PELAKSANAAN PERENCANAAN PERKOTAAN
YANI
KORPORASI
JURUSAN MANAJEMEN

KONSULTAN SIMBOL
TIARA PILAR KREASI, PT
Manajemen & Engineering Consultant
Jl. Raya ...

ESTRUKTUR
ANISYAH LOURELLANDAN, ST, MT
STRUKTUR MANAJEMEN
KEE MANAJEMEN, ST

Detail Project
No. Gambar

DETAIL GREASE TRAP

Skala	No. Gambar	No. Proyek
1:10		PL_07

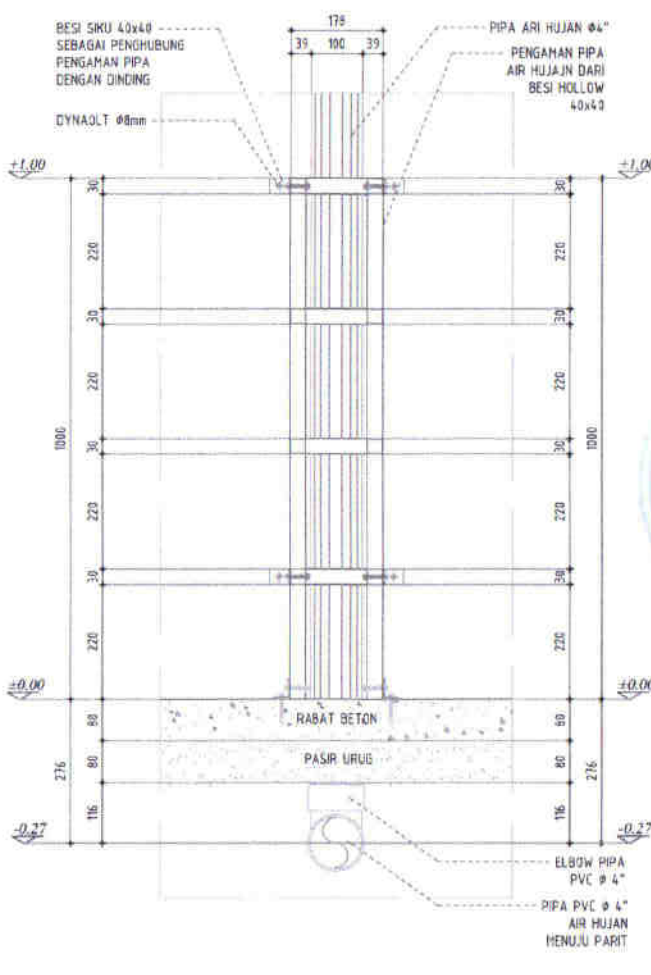
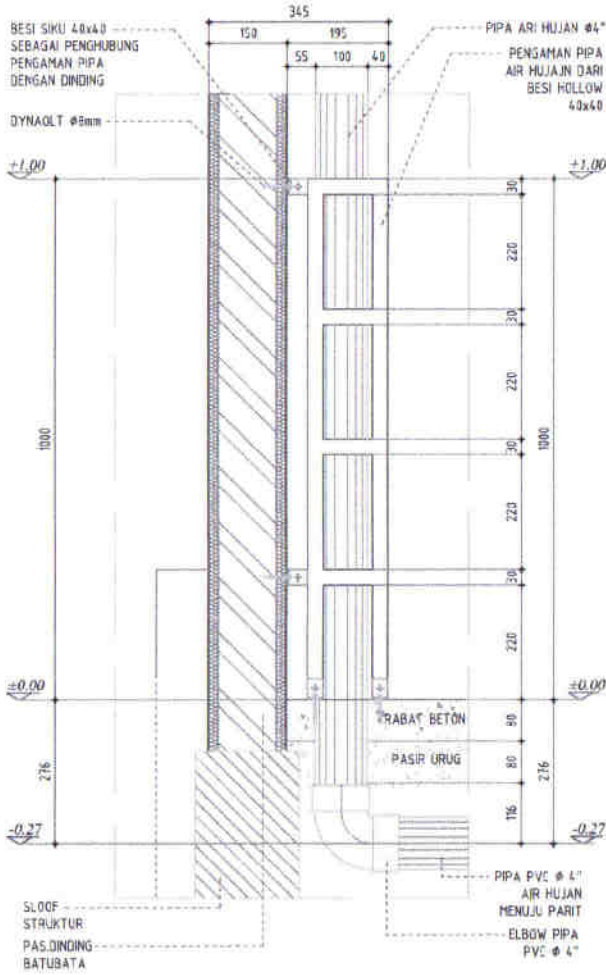
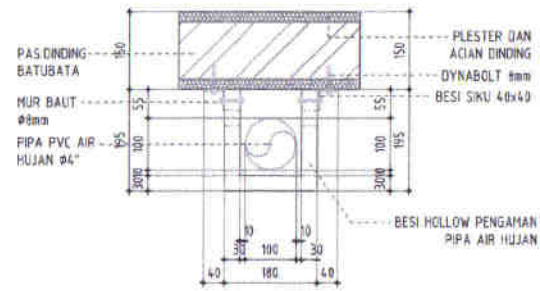
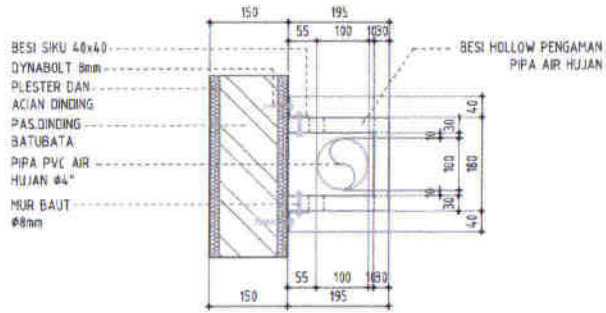

TAMPAK SAMPING PENGAMAN PIPA
SKALA 1:10

TAMPAK DEPAN PENGAMAN PIPA
SKALA 1:10

KETERANGAN

Detail, Detail, Key Plan

NO	REVISI	PARAF		
		RI	RII	RI3

Detail



Manajemen
JENAB KEBAN KORPORASI USAHA BERSAMA DAN PERDAGANGAN
KORPORASI

Manajemen
PELAKSANAAN KONTAKS PERKAWAN

KONSULTAN GAMBAR
TIARA PILAR KREASI, PT
Perencanaan, Desain, dan Pelaksanaan

Desain
Project
Nama Gambar

DETAIL GUIDE RAIL PIPA AIR HUJAN

No.	No. Gambar	No. Proyek
NTS		A.47

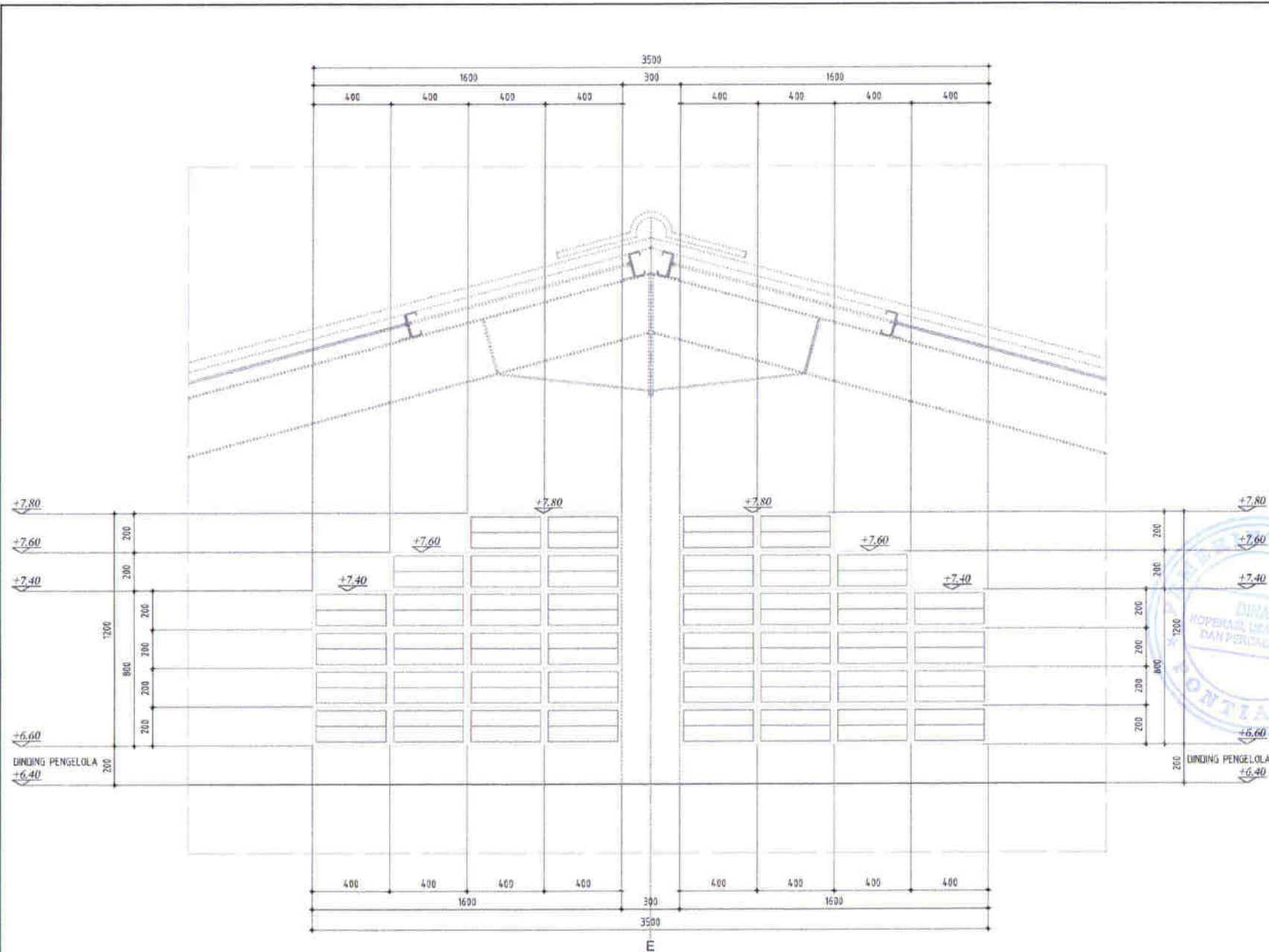

DETAIL ROOSTER
SKALA 1:20

KETERANGAN

Detail Koneksi
Key Plan

NO	REVISI	PARAF		
		IR	R2	R3

Colokan



Manusuhul
KEPALA DINAS KOPERASI, USAHA UKURAN CIKIL PERDAGANGAN DAN PERDAGANGAN

Manusuhul
PELAKSI PENGELOLA KOPERASI, USAHA UKURAN CIKIL PERDAGANGAN DAN PERDAGANGAN

Manusuhul
TIARA PILAR KREANI, PT
Management & Engineering Consultant

Manusuhul
Nama Gambar

Manusuhul
DETAIL PEMASANGAN ROSTER

Skala	No. Gambar	No. Pramb
1:20		A.45

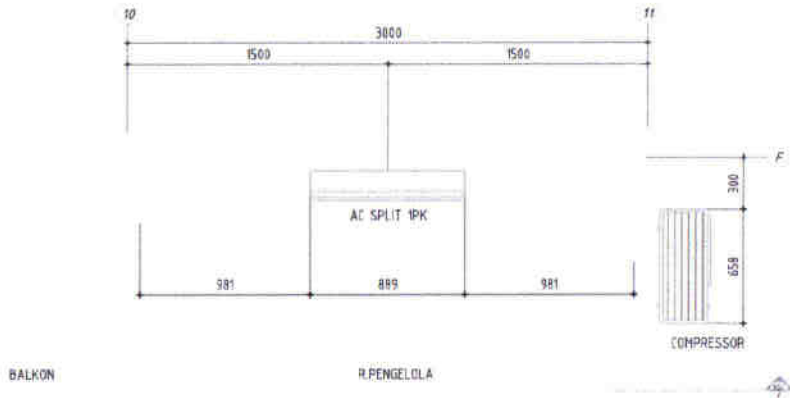

DENAH PENEMPATAN AC
SKALA 1:16

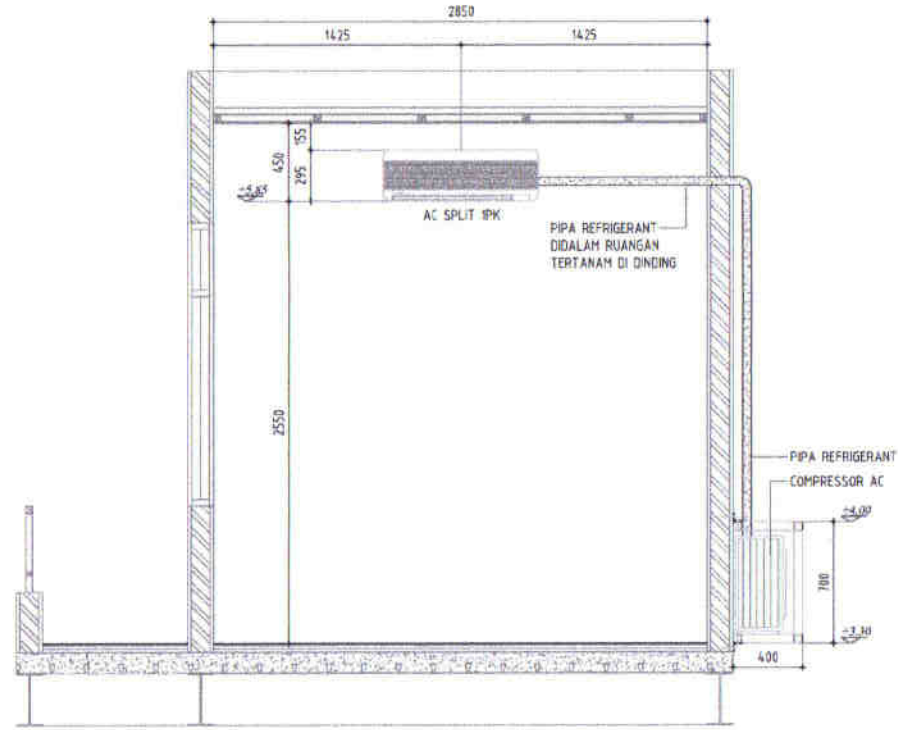

POTONGAN PENEMPATAN AC
SKALA 1:16

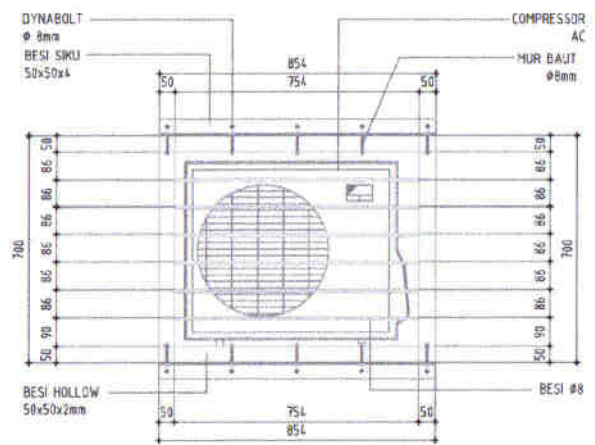

DETAIL PENGAMAN COMPRESSOR 1
SKALA 1:16

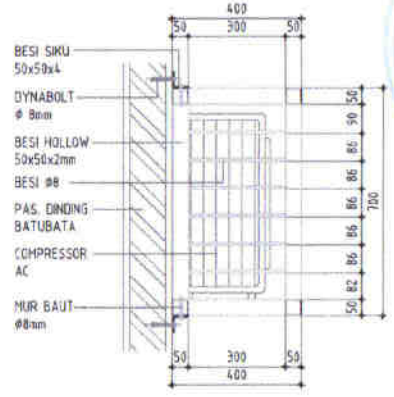

TAMPAK SAMPIING PENGAMAN COMPRESSOR 2
SKALA 1:16

KETERANGAN

Detail, Nomor, Rev. Plan

NO	REVISI	PAJAM		
		MT	RS	K3

Catatan



Manajemen
 UPRA & BINA PERMASALAHAN LINGKUNGAN DAN PERKAWANGAN
 KOTA PONTIANAK

Manajemen
 PELABAT PENYUSUN KONTAK PONDOK
 KONSTRUKSI BANGUNAN
 KOTA PONTIANAK

KONSULTAN GMBH
TIARA PILAR KREASI, PT
 Makasaripati & Karyawati Gedung 2
 Jl. S. H. M. S. No. 100, Pontianak, Kalimantan Barat

TIM TEKNIK
 WRITER: LUKAS WILHELMUS ST, MT
 STRUKTUR: MANUFAKCI, ET
 MEE: WISAPRIZALDI, ST

Proyek
 TIARA PILAR KREASI, PT
 Jl. S. H. M. S. No. 100, Pontianak, Kalimantan Barat

Nama Gambar
 DETAIL PENEMPATAN AC KANTOR

Skala	No. Gambar	No. Proyek
1:16		ME.14

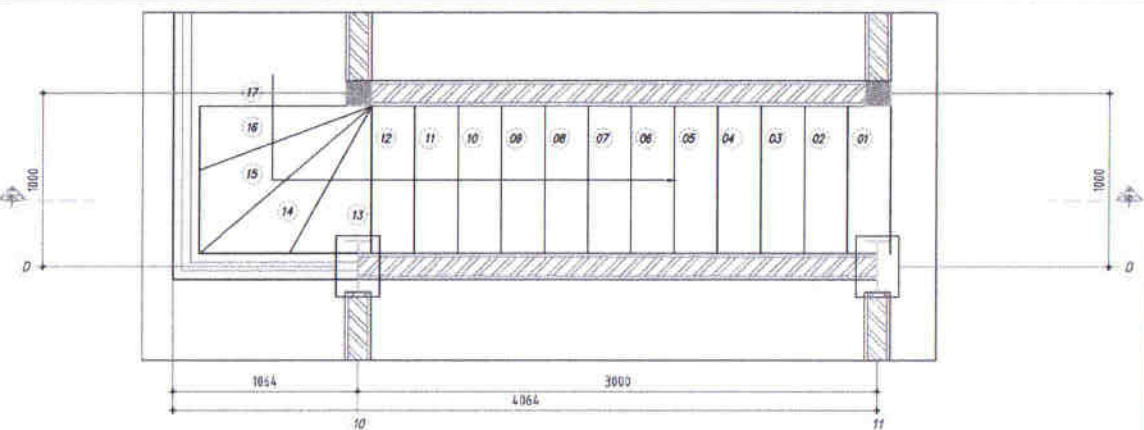

DENAH TANGGA
SKALA 1:30

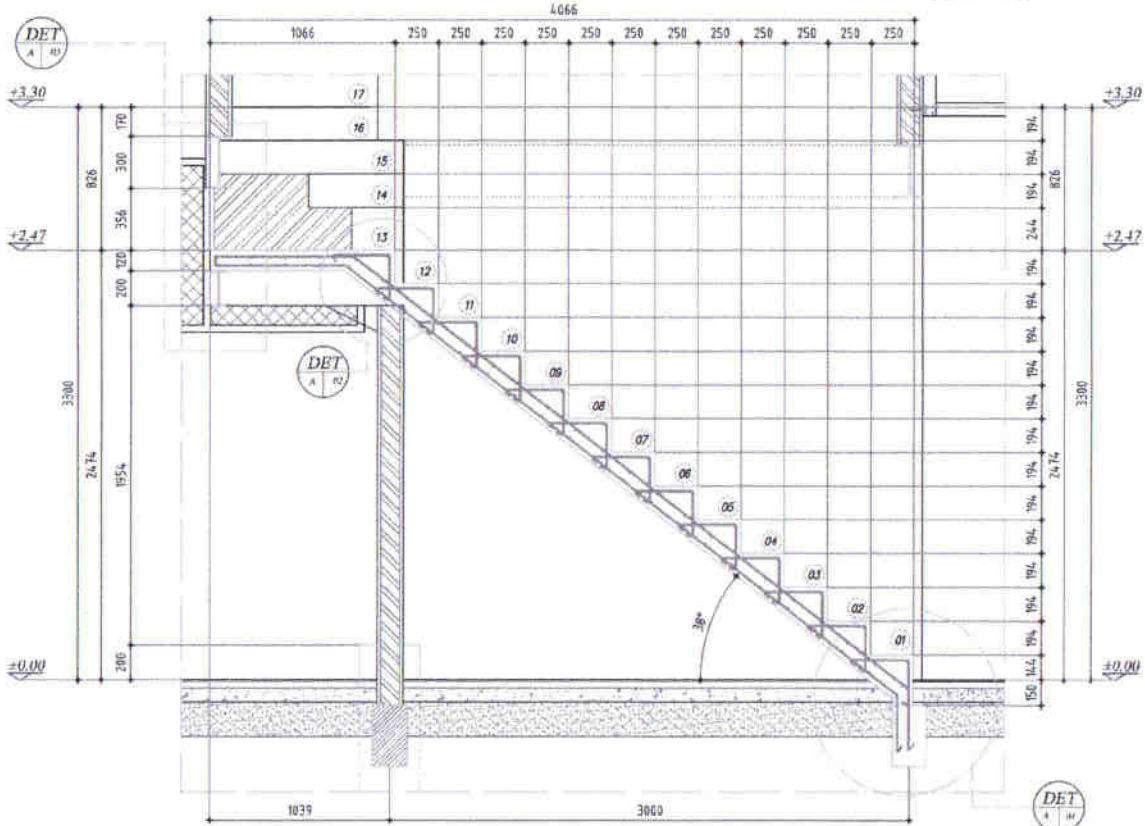

POTONGAN I-I
SKALA 1:30

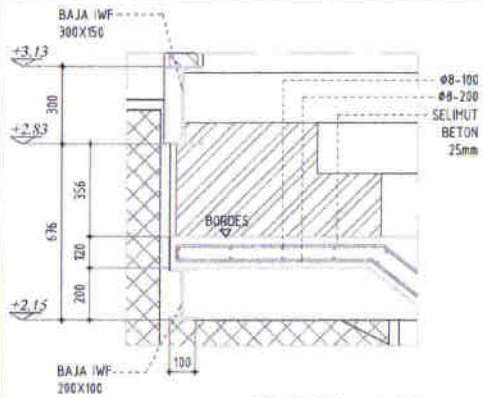

DETAIL A.03
SKALA 1:20

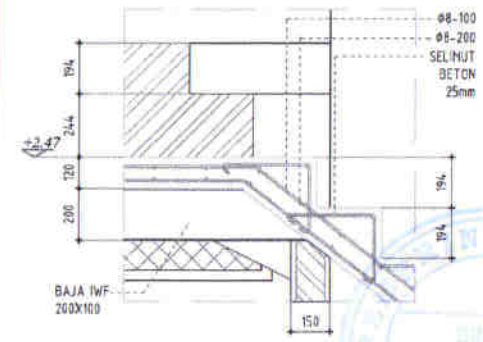

DETAIL A.02
SKALA 1:20

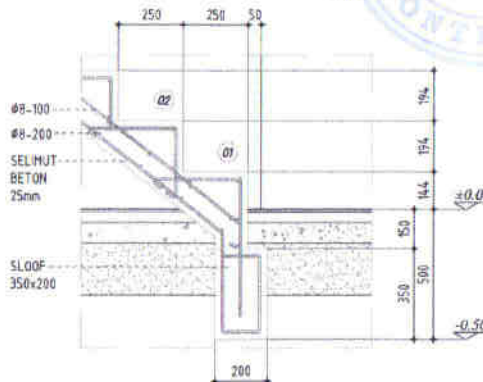

DETAIL A.01
SKALA 1:20

KETERANGAN

Denah, Rasio, Kip, Plan

NO	REVISI	PARAF		
		RI	RS	RS

Situs



Manajemen
KEPALA DINAS HIMPAN, USAHA UMUM DAN PERDAGANGAN
KOTA FORTALIS

Manajemen
PELAKSANAAN KONSTRUKSI

KONSULTAN GIMBAR
TIARA PILAR KRASI, PT
Manajemen & Konsultasi Civil/Struktur

WEN FARRIS

INSYENIR ILMU EKSPLOANSI, ET, ST
STRUKTUR MARIBAU FASE 01

NSI BANGSA TIARA 31

Proyek
Nama Gambar
DETAIL TANGGA

Skala	No. Gambar	No. Proyek
1:20	A.00	A.00

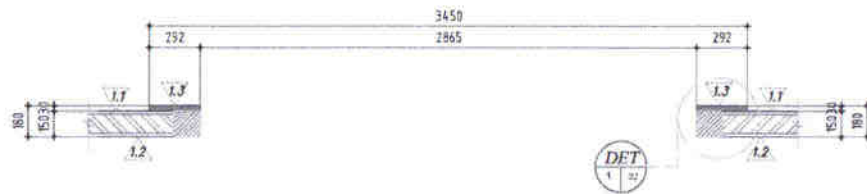
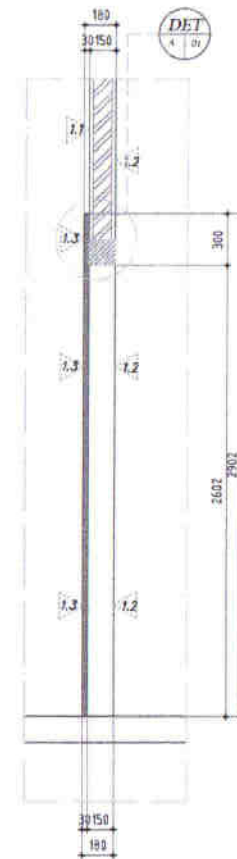
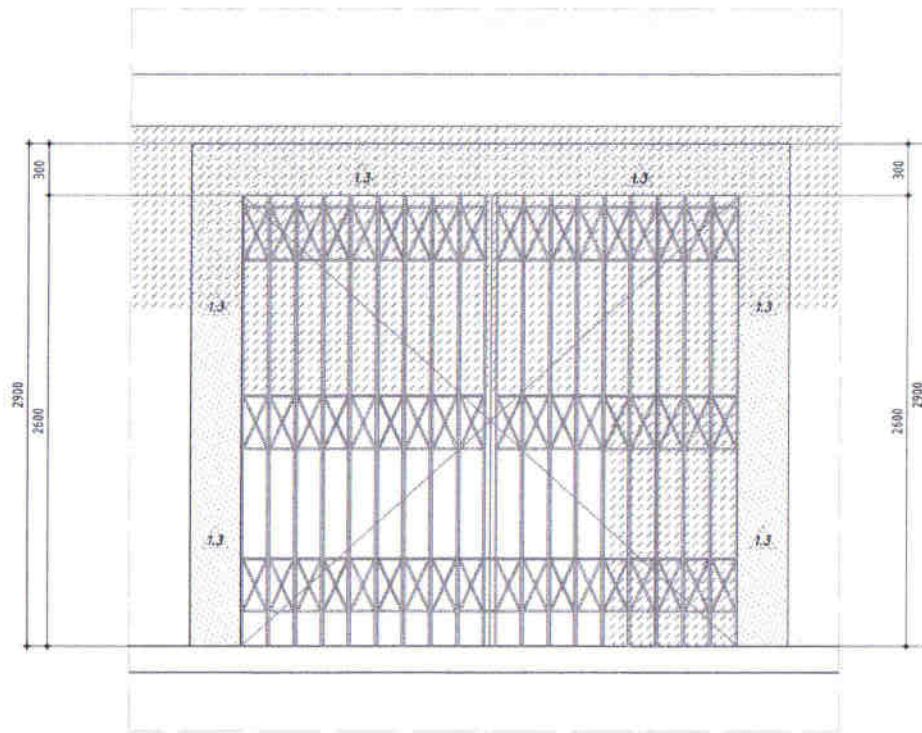

DETAIL PENEBALAN DINDING PINTU MASUK UTAMA

SKALA 1:30

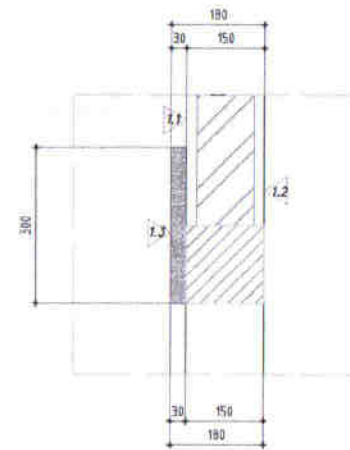

DETAIL A.01

SKALA 1:10

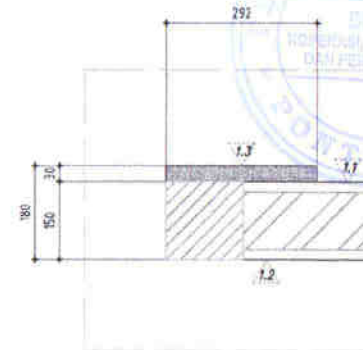

DETAIL A.01

SKALA 1:10

KETERANGAN

Detail Kusen
Key Plan

NO	REVISI	PARAF		
		RI	RI2	RI3

Catatan

Uraian
Catatan



Manufaktur

KEPALA DINAS ADVISED: LEMBAGA DAN PERDAGANGAN
KOTA PORTUGAL
[Signature]
DINAS PERDAGANGAN DAN PERDAGANGAN

Manufaktur

PELAKSANAAN KEMENTERIAN PERDAGANGAN
[Signature]
DINAS PERDAGANGAN DAN PERDAGANGAN

KONSULTAN GABUNG

TIARA PILAR KREASI, PT
Management & Engineering Consultant
Jl. ...

YAN THOMAS

ARBITER: USUNG USUNG, ST, AP *[Signature]*

DEKONTOR: MANUANG, ST *[Signature]*

REK: ... *[Signature]*

Proyek
Project

Notes
Gambar

Skala	No. Gambar	No. Proyek

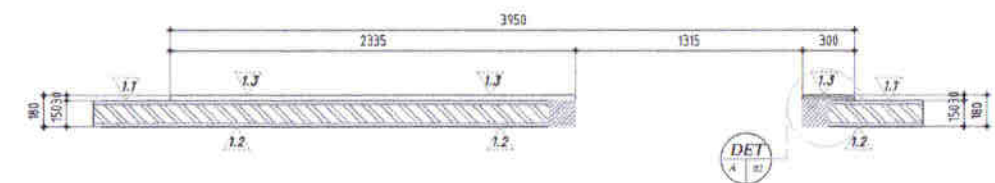
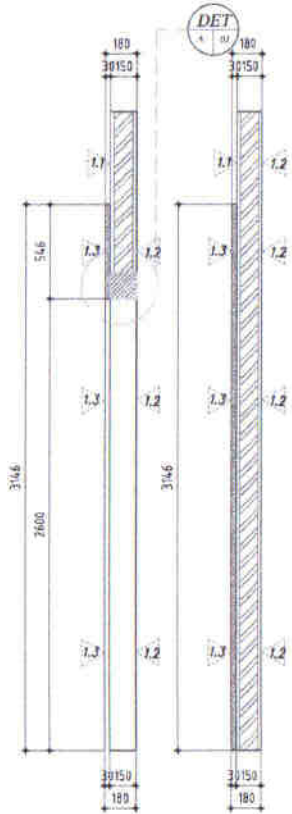
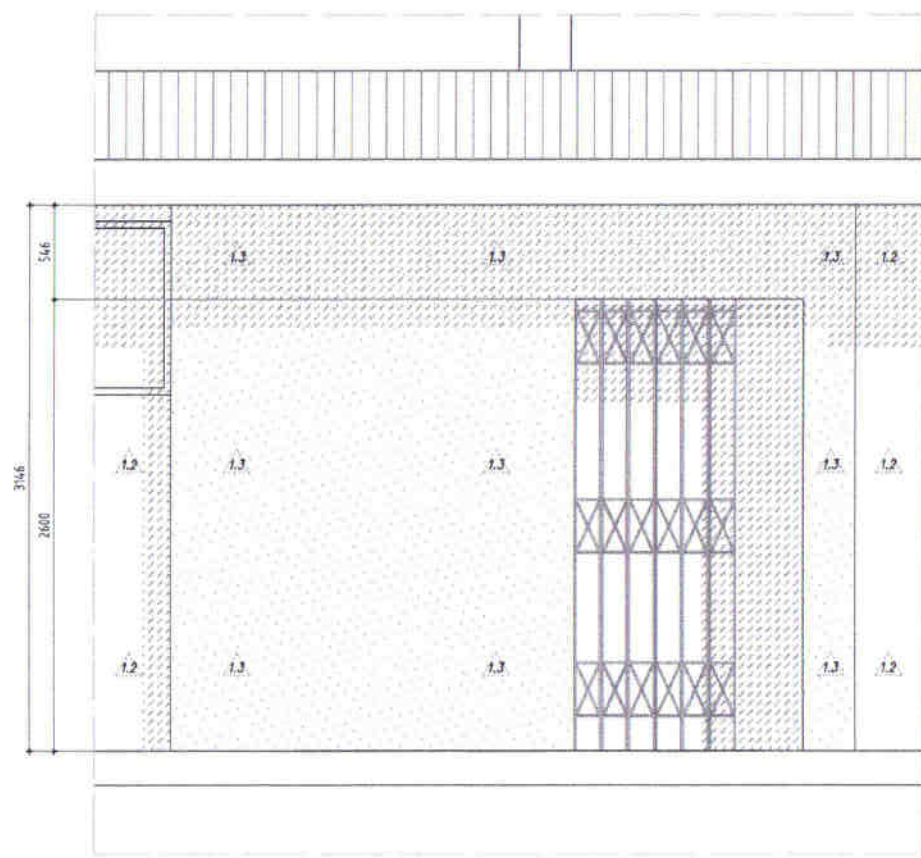

DETAIL PENEBALAN DINDING PINTU MASUK SAMPING LUAR
SKALA 1:30

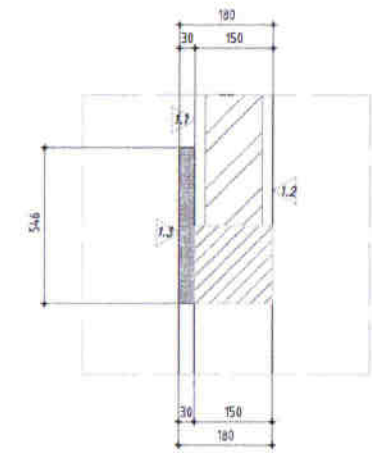

DETAIL A.01
SKALA 1:10

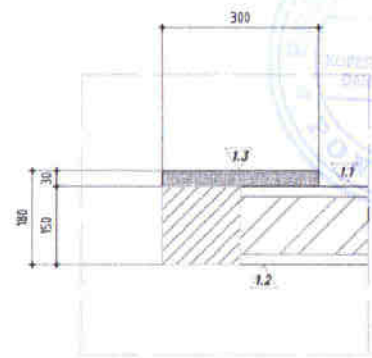

DETAIL A.01
SKALA 1:10

KETERANGAN

Detail, Rinci, Any Plan

NO	REVISI	PARAF		
		R1	R2	R3

Substansi



Mengesah
DIREKTORAT JENDERAL USAHA MIKRO DAN PERDAGANGAN
ATAU PERDAGANG
[Signature]
DIREKTOR JENDERAL
DIREKTORAT PERDAGANGAN

Mengesah
PEMBAT PEBUKT HAKIMEN PEROH
[Signature]
SALAH SUDHARTO, S.T.
PEMBAT PEBUKT HAKIMEN PEROH

KONSULTAN JENJANG
TIARA PILAR KREASI, PT
KONSULTAN JENJANG
KONSULTAN JENJANG

YAK THORIS
ARHIT: ULUS HILANDI, S.T.
URUKER: WIRAWAN, S.T.
MSE: BRAMS TJUH, S.T.

Project
Project
Project

Nama Gambar

Scale	No. Gambar	No. Proyek

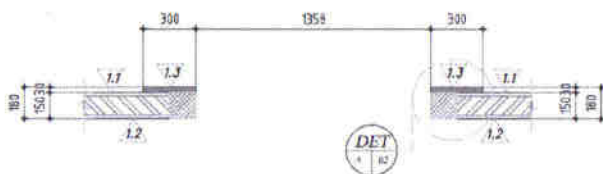
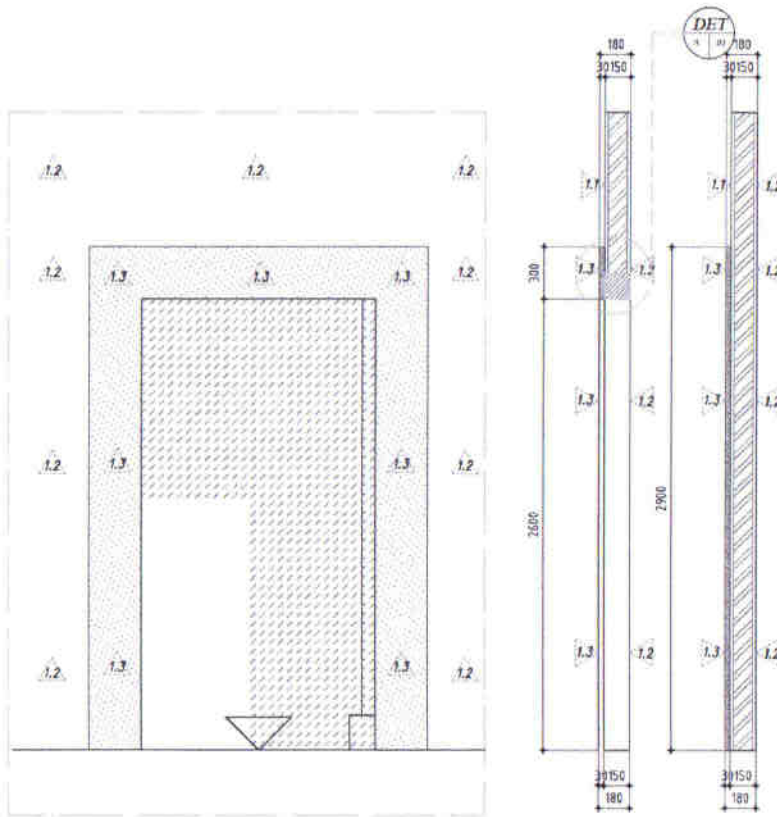

DETAIL PENEBALAN DINDING PINTU MASUK SAMPING DALAM

SKALA 1:30

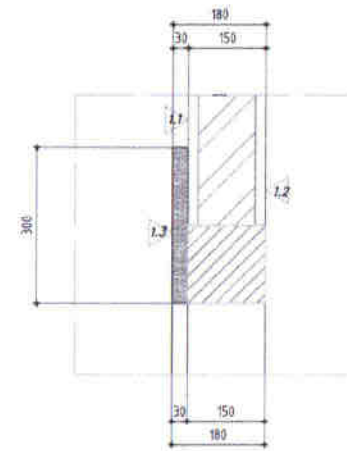

DETAIL A.01

SKALA 1:10

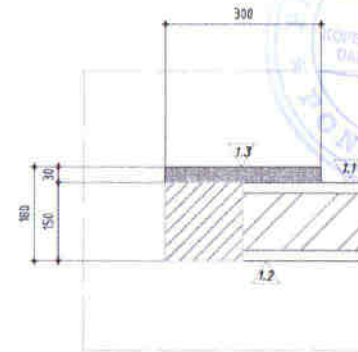

DETAIL A.01

SKALA 1:10

KETERANGAN

Detail, Kambel, Key Plan

NO	REVISI	PARAF		
		RD	R2	R3

Catatan

Logo of the Ministry of Trade, Republic of Indonesia, with the text: KEMENTERIAN REPUBLIK INDONESIA, DEPT. OF TRADE, Jl. Medan Merdeka No. 1, Jakarta 10110, Indonesia.

Mengesahul
 REPUBLIK INDONESIA, DEPT. OF TRADE, Jl. Medan Merdeka No. 1, Jakarta 10110, Indonesia.

Mengesahul
 REPUBLIK INDONESIA, DEPT. OF TRADE, Jl. Medan Merdeka No. 1, Jakarta 10110, Indonesia.

KONSULTAN GIMBAR
TIARA PILAR KREASI, PT
 Jl. ...

YON THOMAS
 ARSITEK: ...
 STRUKTUR: ...
 MEE: ...

Project
 ...

Nama Gambar

Skala	No. Gambar	No. Proyek

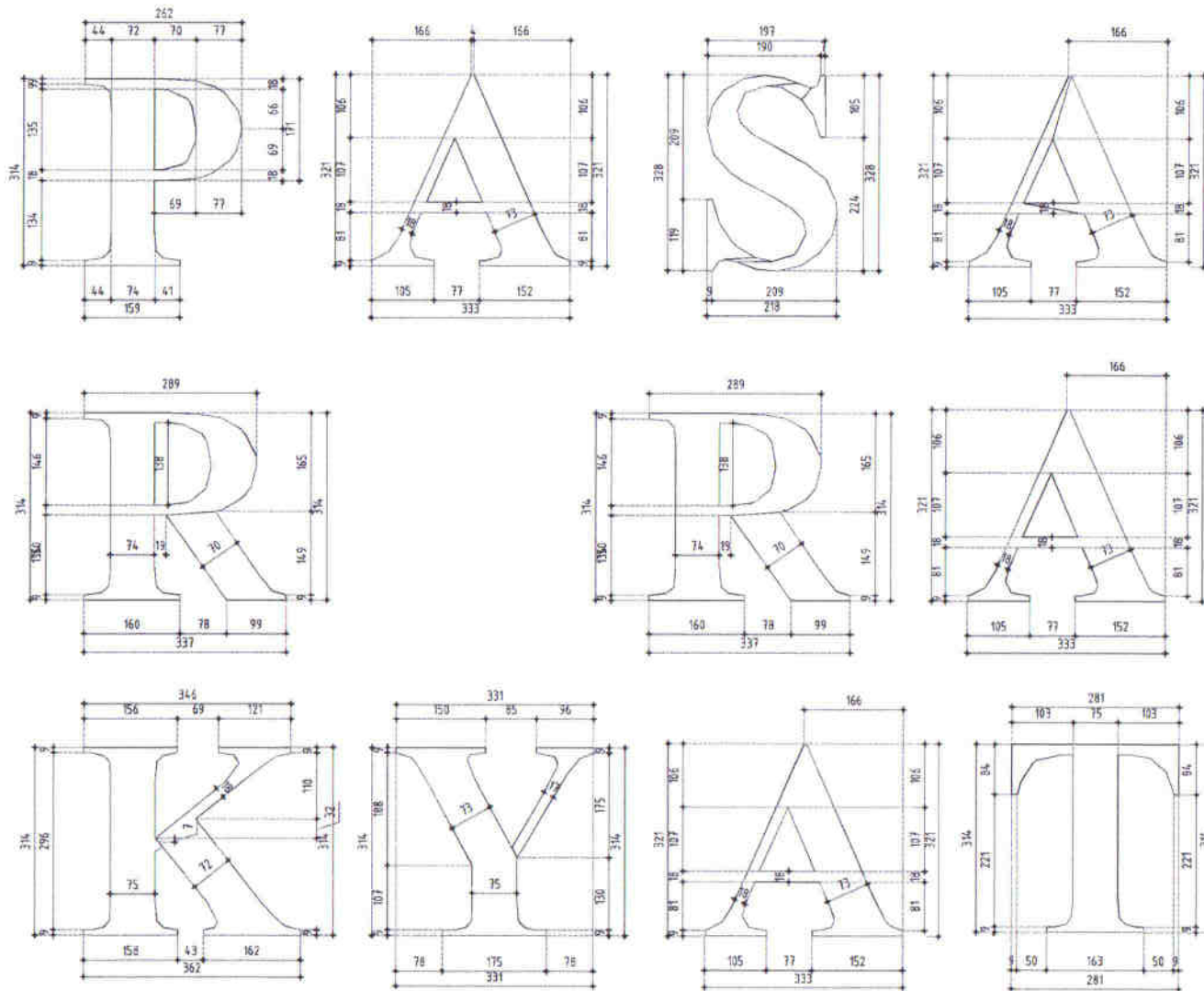

KETERANGAN

Depth, Height, Key Plan

NO	REVISI	PARAF		
		PI	PII	PI3

Detail

Scale

KEMENTERIAN REPUBLIK INDONESIA
 MINISTRY OF TRADE
 Jl. Medan Merdeka No. 1
 Jakarta Pusat, 10119 Indonesia

Mengetahui
 DIREKTORAT KEPERLOM, TRANSPORT DAN PERDAGANGAN
 KOTA PONTIANAK
[Signature]
 DIREKTUR DAERAH
 KOTA PONTIANAK

Mengetahui
 PELAKSANA PERALIHAN PERUSAHAAN
[Signature]
 BERKAS PERUSAHAAN
 KOTA PONTIANAK

KONSULTAN CADANGAN
TIARA FILAR KREANI, PT
 Manufaktur & Ekspansi Konsultan
 Jl. ...
 ...

TIM TEKNIK
 MESTER: LOUIS HILANDAL ST, ST
 STRUKTUR: MUHAMMAD FALIC ST
 MEK: MURAHIDJAL ST

Project
 ...

Nama Gambar

Slide	No. Gambar	No. Proyek



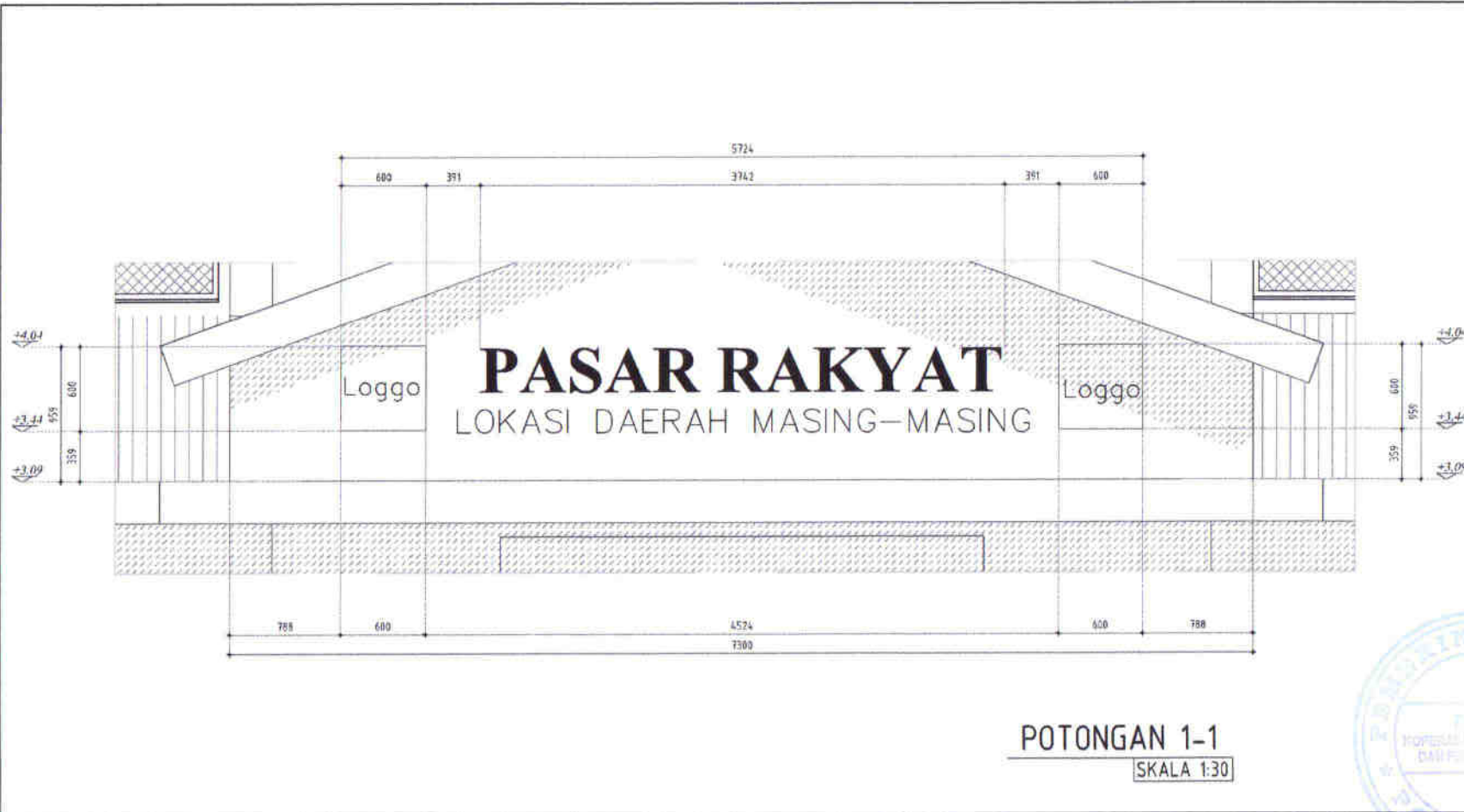

POTONGAN 1-1
SKALA 1:30

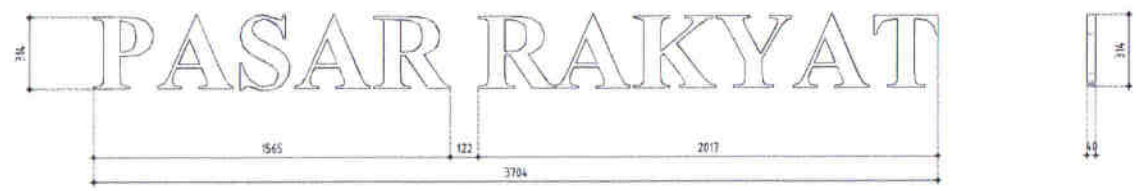

DETAIL TEXT 1
SKALA 1:20

KETERANGAN

Detail Item
Key Plan

NO	REVISI	PARAF		
		R1	R2	R3

Catatan
- MATERIAL SIGNAGE TERBUAT DARI ALUMINIUM



Mengetahui
KEPALA DINAS KEMERDEKAAN USAHA KECIL DAN TENGAHAN USAHA
YOGYA PURWANA

Mengetahui
KORPORASI PERUSAHAAN
KORPORASI PERUSAHAAN

KONSULTAN GMBH
TIARA PILAR KREASI PT
Management & Engineering Consultant

TIM TEKNIS

ARHITEK	LORENA SEKARJATI, ST, MT	
STRUKTUR	MAHARANI FATMA ST	
MEE	IRAHMI ZEIN ST	

Disusun
Project

Project Location: Jl. ...
Project No. ...

Nama Gambar

Scale	No. Gambar	No. Proyek

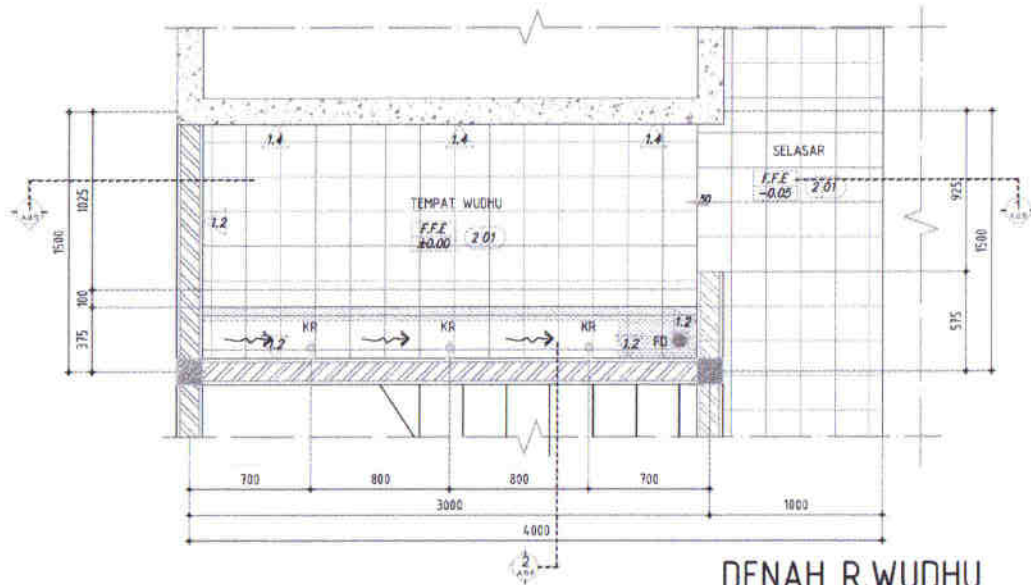

DENAH R. WUDHU

SKALA 1:30

KETERANGAN :

- 1.1 : DINDING FINISH CAT EXTERIOR WARNA PUTH
- 1.2 : DINDING FINISH CAT INTERIOR WARNA PUTH
- 1.3 : DINDING FINISH KERAMIK 20x20 WARNA ABU-ABU
- 1.4 : DINDING BETON
- 2.01 : LANTAI KERAMIK 20x20 WARNA ABU-ABU
- 2.02 : LANTAI KERAMIK 20x20 WARNA PUTH
- 2.03 : LANTAI KERAMIK 20x20 2 WARNA UNTUK KIDS
- F.F.E -0.05 : FLOOR FINISH ELEVATION/ ELEVASI LANTAI

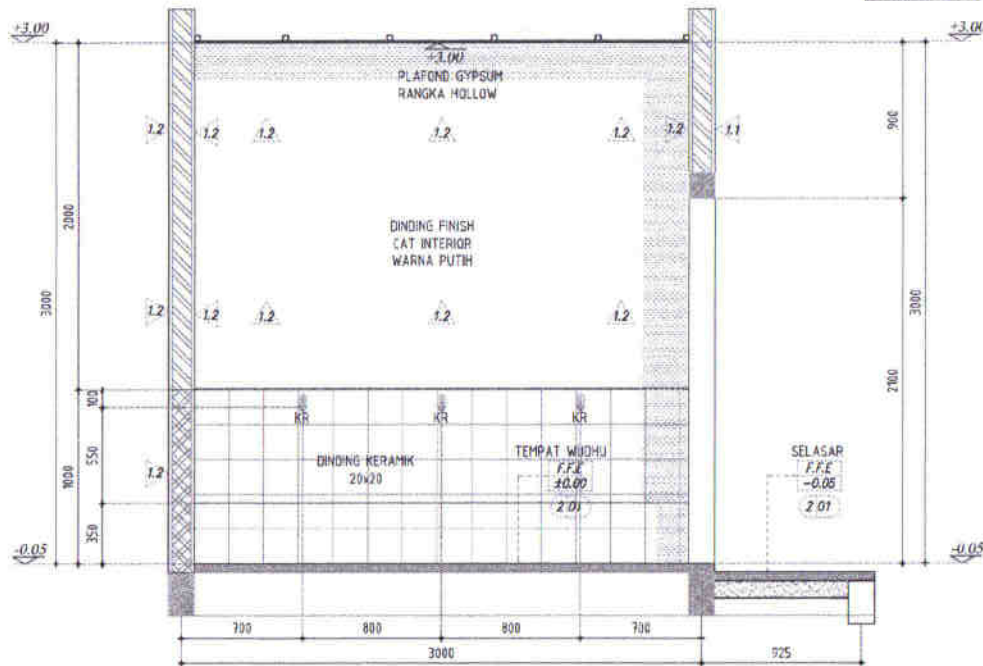

POTONGAN 1-1

SKALA 1:30

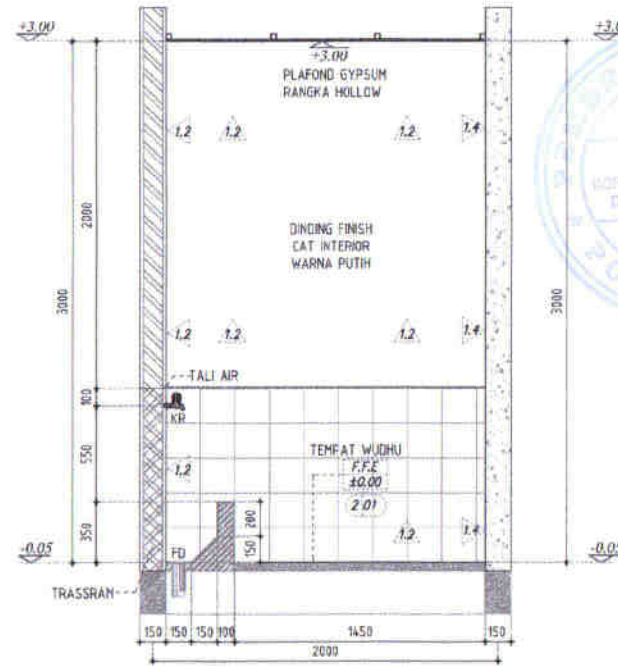

POTONGAN 2-2

SKALA 1:30

KETERANGAN

Daerah Kerja
Key Plan

NO	REVISI	PARAF		
		R1	R2	R3

Catatan

Klien
Client



Mengabikan

REPUBLIC OF INDONESIA
KEMENTERIAN PERDAGANGAN
REPUBLIC OF INDONESIA
MINISTRY OF TRADE

REPUBLIK INDONESIA
KEMENTERIAN PERDAGANGAN
REPUBLIC OF INDONESIA
MINISTRY OF TRADE

Mengabikan

PLANNING ENGINEER

PLANNING ENGINEER

MENGABIKAN GAMBAR

TIARA PIJAR BIREANI, PT
Development & Engineering Consultant

YEN EKORIS

ARQUIT : LOUIS WILHELMUS, ST, MT

STRUKTUR : MARIANUS PALSY

MEK : BRUNO JULIA, ST

Daerah Kerja
Project

PROJECT

Nama Gambar

Skala	No. Gambar	No. Proyek

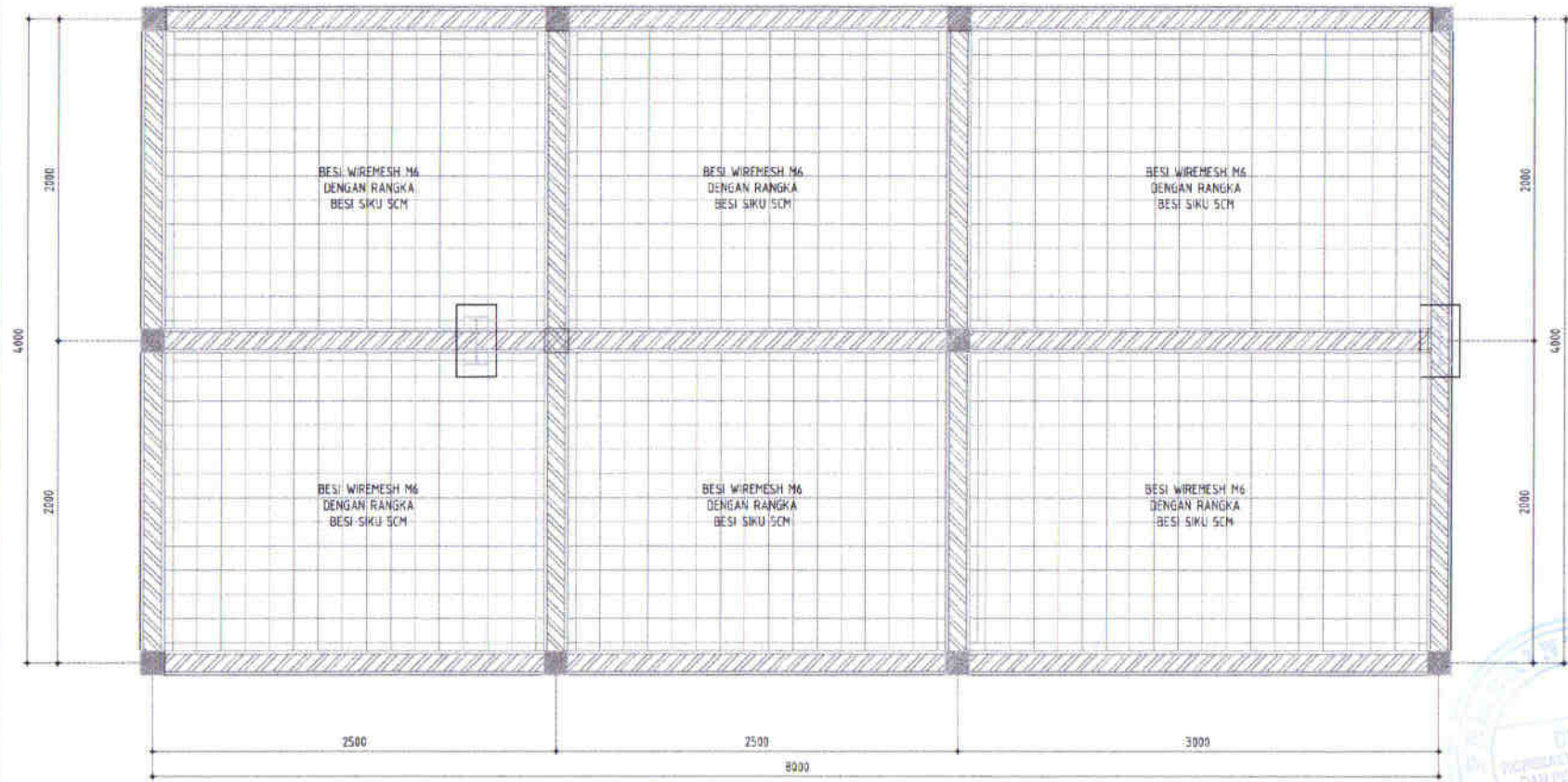

DENAH TRALIS PLAFON
SKALA 1:30

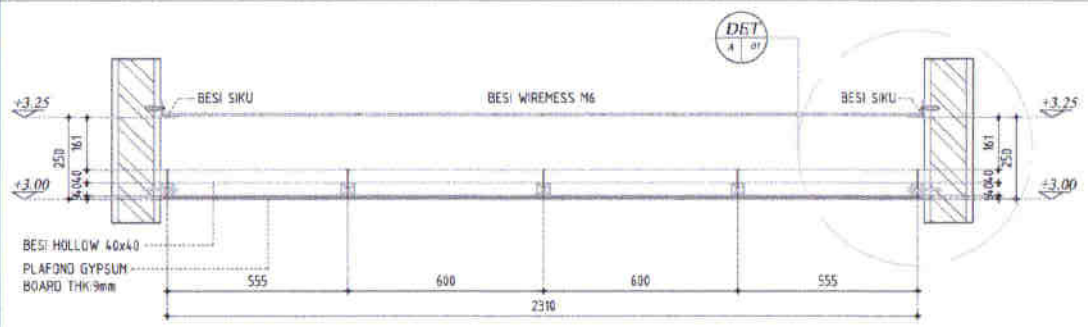

POTONGAN
SKALA 1:16

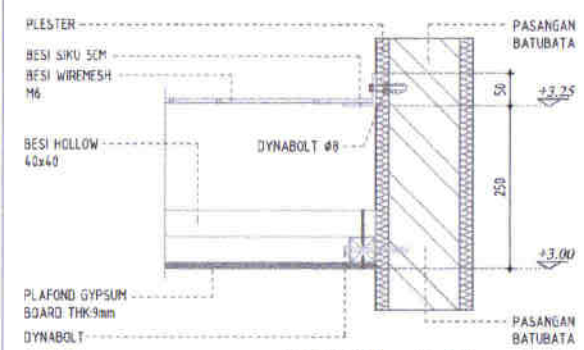

DETAIL A.01
SKALA 1:8

KETERANGAN

Daftar Mendaftar
Key Plan

NO	REVISI	PARAF		
		H1	H2	H3

- Legenda
- CL : CLOSET
 - FD : FLOOR DRAIN
 - WS : WASHTAFEL
 - UR : URINGIR



Mengetahui

KEMENTERIAN PERDAGANGAN
REPUBLIK INDONESIA

[Signature]

KELOMPOK TEKNIK DAN PERENCANAAN
DOKUMENTASI

Mengetahui

PROJEK PERENCANAAN KONTROL PROJEK

[Signature]

KELOMPOK TEKNIK DAN PERENCANAAN
DOKUMENTASI

KONSTRUKSI GAMBAR

TIARA PILAR KREASI, PT
Manajemen & Engineering Consultant

TIM TEKNIS

ARQUIT : IZZET RAHMADU ST, MT

STRUKTUR : WAHABUS PAZ ST

MEC : IMRAN RAH ST

Proyek
Project

Nama Gambar

Skala	No. Gambar	No. Revisi



DENAH DISTRIBUSI ARUS LISTRIK AREA KIOS
 SKALA 1:200

KETERANGAN

Desain, Gambar, Rev. Poin

NO	REVISI	PARAF		
		RI	RII	RIII

Catatan

Klien



MINISTRY OF TRADE
 REPUBLIC OF INDONESIA

Merespon

KEANEK DINDO HONORABIL USWA NAMP DIN PERMENDAGRI
 KOTA PONDOK WAWI



KEANEK DINDO
 082291188111

Merespon

PERUMAH PERMENDAGRI KOTA PONDOK WAWI



PERUMAH PERUMAH
 082291188111

KONSULTAN GAMBAR



TIARA PILAR KREASI, PT
 Management & Engineering Consultant

TIM TENNIS

REVISOR	LOUISE BRANDON, ST, MT	
STRUKTUR	WUMBURO PAT, ST	
MCE	BRANDI ZULK, ST	

Project
 Project

Nama Gambar

DENAH DISTRIBUSI ARUS LISTRIK KIOS

Skala	No. Gambar	No. Proses
1:200		ME 04

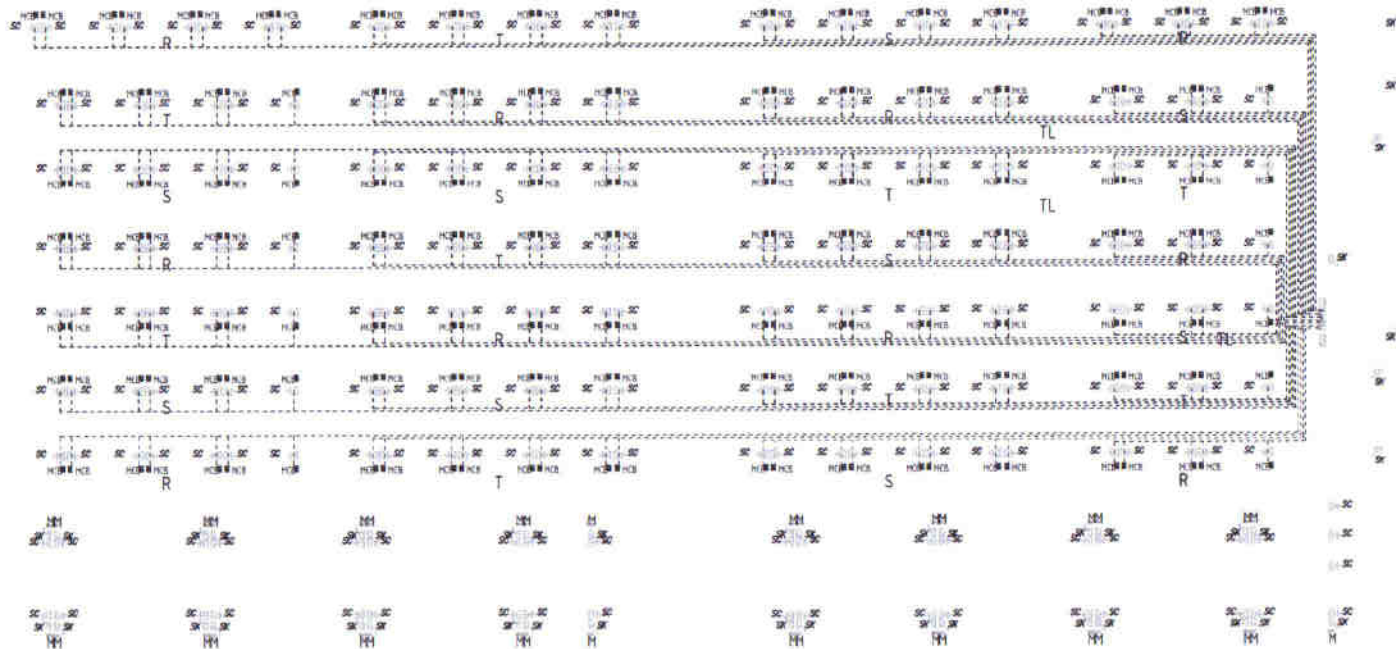

DENAH DISTRIBUSI ARUS LISTRIK AREA LOS

SKALA 1:200

KETERANGAN

Daerah, Nomor, Key Plan

NO	REVISI	PARAF		
		R1	R2	R3

Coloris



Manajemen

KEPALA DINAS KEPERAWATAN DAN BIDANG PEMERIKSAAN
KELAS BANTUAN

Manajemen

KELOMPOK PERKULIAHAN (PKK)

KELOMPOK TANI (KOTAN)

TIARA PILAR KREASI, PT
Manajemen & Engineering Consultant

TIM TEKNIK

MITOS: LOUISE MALINDAL ST. MT

RIKALDI: RIHARDI HAS ST

DEE: KEVIN ZALDI ST

Project

Nama Gambar

DENAH DISTRIBUSI ARUS LISTRIK LOS

Skala	No. Gambar	No. Proyek
1:200		ME.03

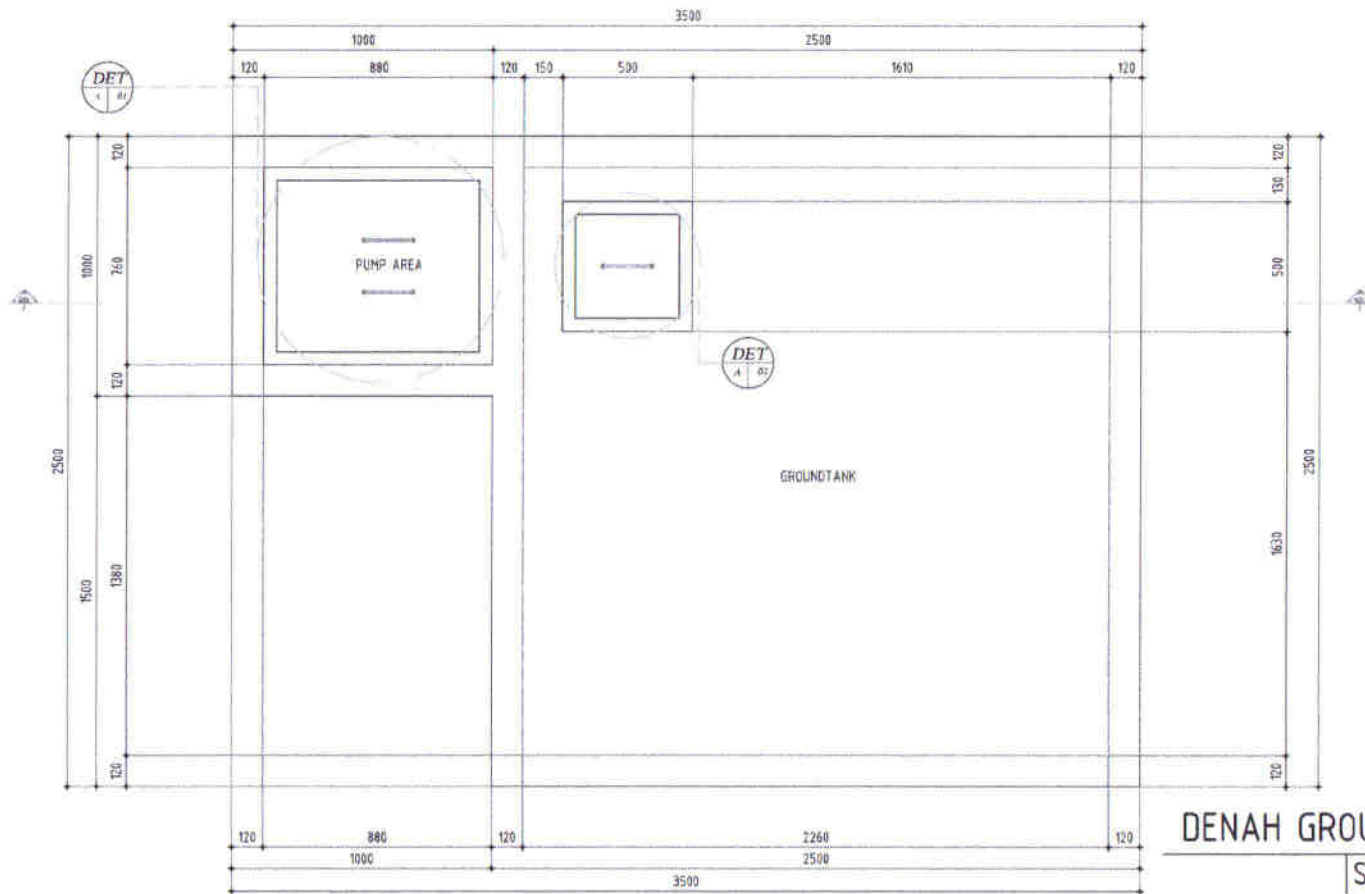

DENAH GROUND TANK
SKALA 1:20

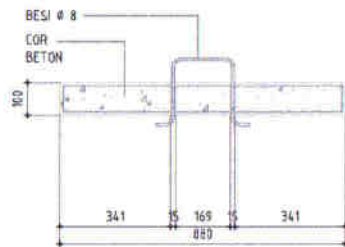

DETAIL A.01
SKALA 1:16

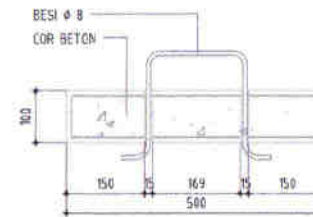
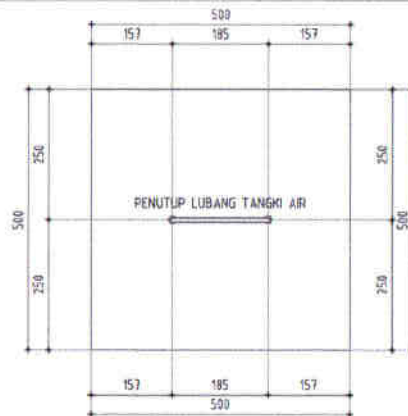

DETAIL A.02
SKALA 1:10

KETERANGAN

Detail, Kavel, Rev. Plan

NO	REVISI	PABAT		
		RI	RII	RIII

Catatan

Logo Client



Manufaktur



Manufaktur



KONSULTAN GAMBAR



TIM TEKNIK

ARWIT	LOUIS EZE WIDHI, ET. MT	<i>[Signature]</i>
STRUKTUR	MARWAN FACHRI ET	<i>[Signature]</i>
MEK	BRIHAN DARUL ET	<i>[Signature]</i>

Project

Nama Gambar

DENAH GROUND TANK

Skala	No. Gambar	No. Proyek
1:10		PL.09

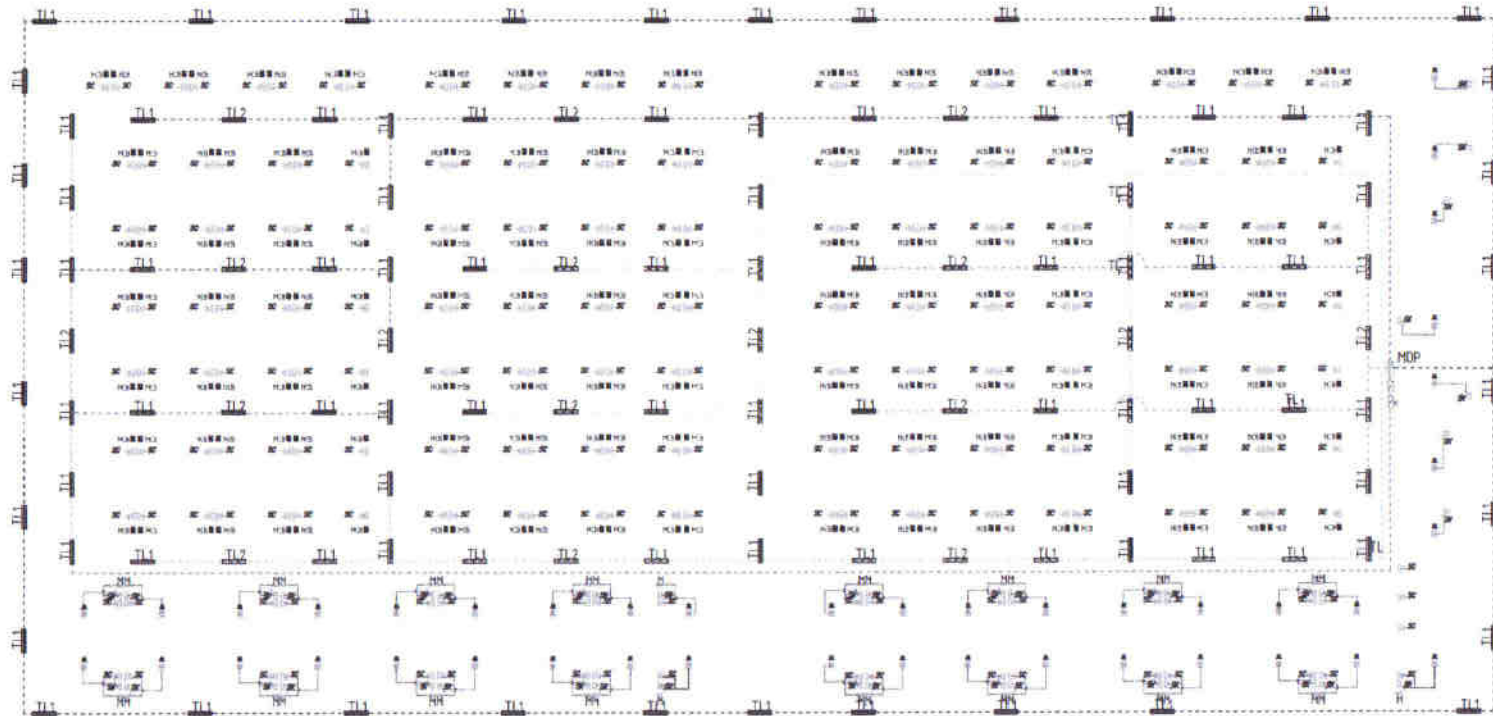

DENAH INSTALASI TITIK LAMPU LANTAI 1
SKALA 1:200

KETERANGAN

Revisi
Revisi

NO	REVISI	PARAF		
		R1	R2	R3

Catatan

Sin. Client



MINISTRY OF TRADE
Jl. Puloasri No. 1
Jakarta Pusat 10110 Indonesia

Meterai

NOVA LINDA KORNELI, LOKASI MANAJEMEN DAN PERENCANAAN
ATAK PERENCANAAN

[Signature]
NOLVA LINDA KORNELI

Meterai

PLANNING CONSULTING INDONESIA (PT)

[Signature]
SUDHARMO, S.T., M.P.

KONSULTAN GAMBAR



TIARA PILAR AREA, PT
Manajemen & Engineering Consultant

TITAN TERIMA

ARSITEK : LOUIS WANDARAL ST., ST.

STRUKTUR : MURNIANDI FALIST

MEK : WIKIRAZULAN, ST.

Proyek / Project

MANAJEMEN DAN PERENCANAAN
Gedung 1 - ...

Nama Gambar

DENAH INSTALASI TITIK LAMPU LANTAI 1

No.	No. Gambar	No. Prosk
1200		ME.01

KETERANGAN

Daftar, Nomor
Rev. Plan

NO	REVISI	PARAF		
		M	R2	R3

Catatan



Manajemen
KEPALA DINAS SUPERVISI USAHA MUDA DAN PERENCANAAN
KOTA PONTIANAK
[Signature]
JANUARY 2018

Manajemen
PELAKSANAAN PERENCANAAN DAN KONTROL
[Signature]
WALID SURIPATTA, S.T., M.T.
Manajemen

MANAJEMEN GAMBAR
TIARA PILAR KREASI, PT
Management & Engineering Consultant
Jl. ...

TEKNIK
LOKASI: ...
STRUKTUR: ...
KEL: ...

Proyek
Project

Nama Gambar
DENAH INSTALASI TITIK LAMPU LANTAI 2

Skala	No. Gambar	No. Proyek
1:200		ME.02

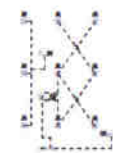

DENAH INSTALASI TITIK LAMPU LANTAI 2
SKALA 1:200



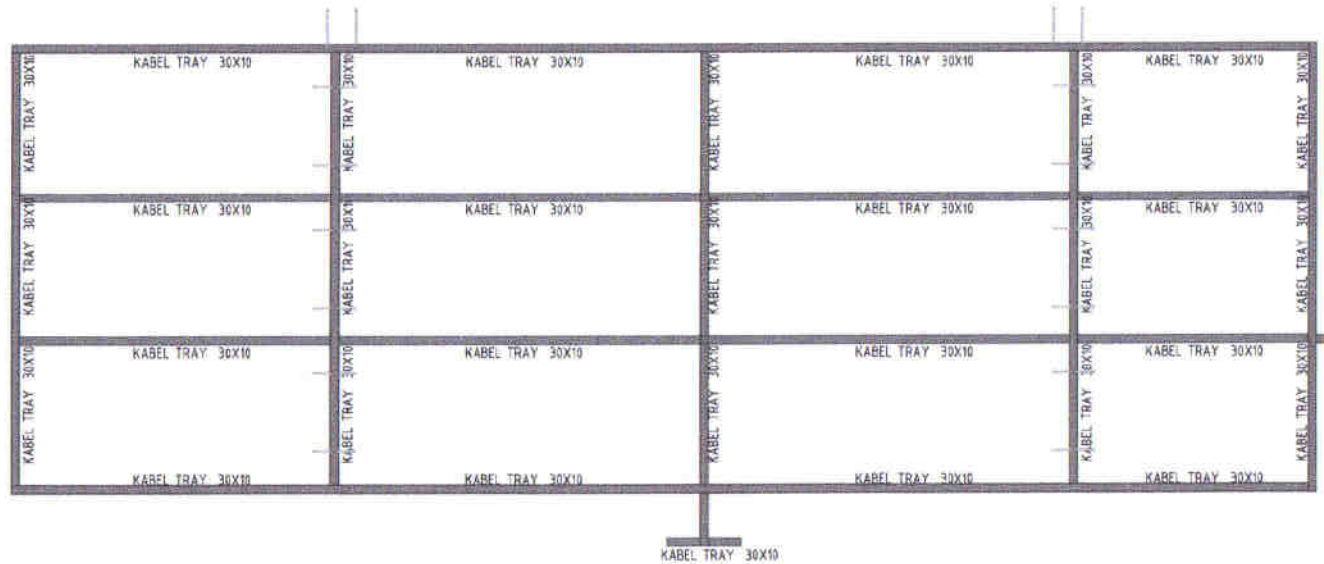

DENAH KABEL TRAY
SKALA 1:200

KETERANGAN

Detail Kabel Tray Plan

NO	REVISI	PARAF		
		MT	RS	RS

Customer

Klien / Client

MINISTRY OF TRADE
100000 Jalan Sudirman, 5
Jakarta Pusat, 10110 Indonesia

Manajemen

KEPALA DINAS IKT/INFORMATIKA DAN TEKNOLOGI
KEMENTERIAN PERDAGANGAN
REPUBLIC OF INDONESIA

Manajemen

KELOMPOK PERUSAHAAN STRATEGIS (KPS)

Manajemen

PT. TIARA PILAR KREASI, PT.
Management & Engineering Consultant
Jl. Raya Cempaka Putih No. 10, Jakarta Pusat, 10110 Indonesia

TEN TERIMA

ANALIS: LUISA WALIKOW, ST, MT

STRUKTUR: NAWANIQI FIZ, ST

ACE: RAHMADZAH, IT

Proyek / Project

Manajemen

Denah Kabel Tray

Skala	No. Gambar	No. Proyek
1:200		ME-11

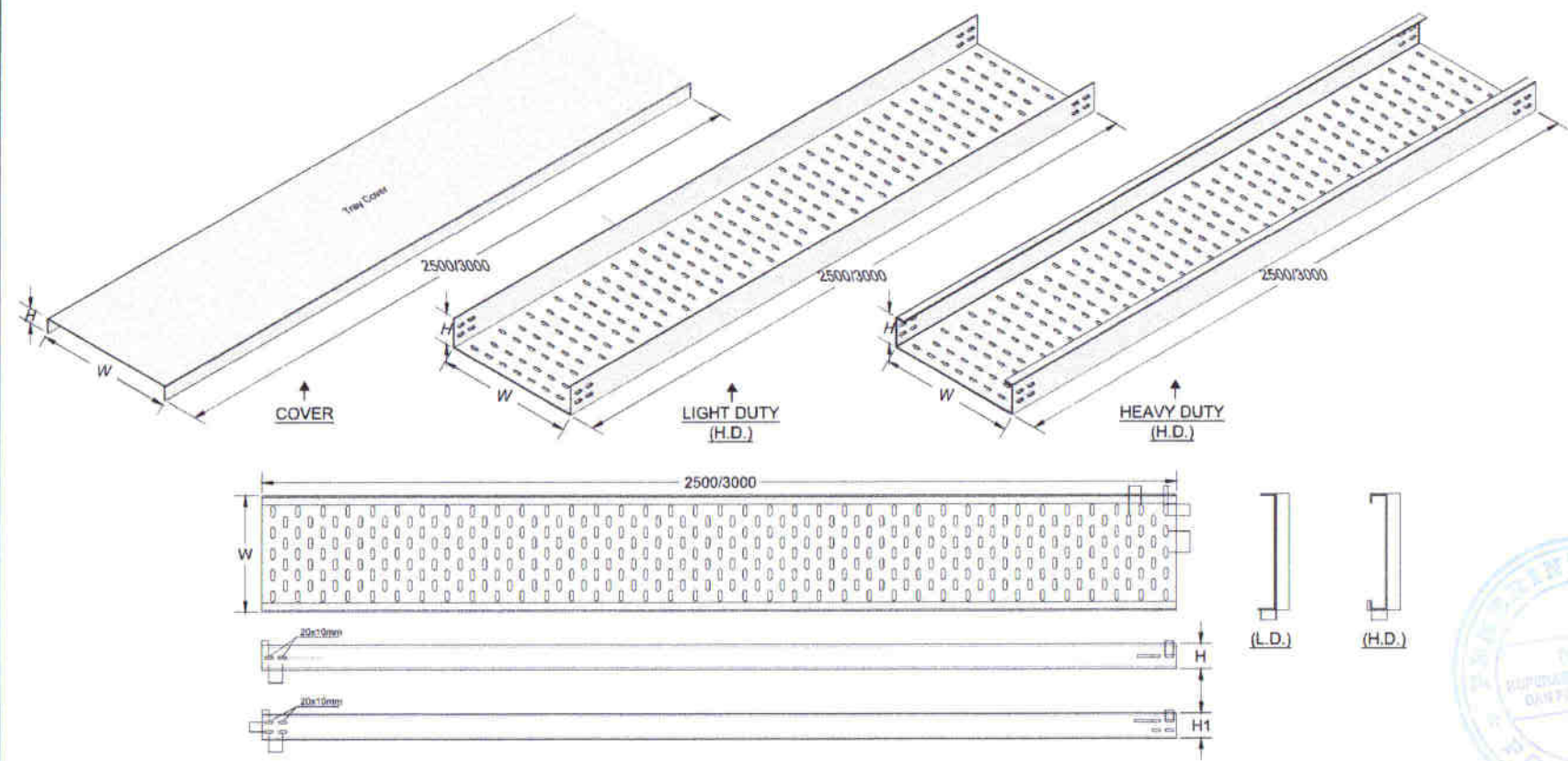

ISOMETRI KABEL TRAY
SKALA NTS

KETERANGAN

Revisi
No. / Revisi

NO	REVISI	PARAF		
		RI	RS	RS

Calon



Manajemen

Manajemen

PT TIARA PILAR KREASI, PT

TIM TEKNIS

ARSITEK

STRUKTUR

MSE

Project

Nama Gambar
DETAIL KABEL TRAY

Skala	No. Gambar	No. Prosep
NTS		ME.13

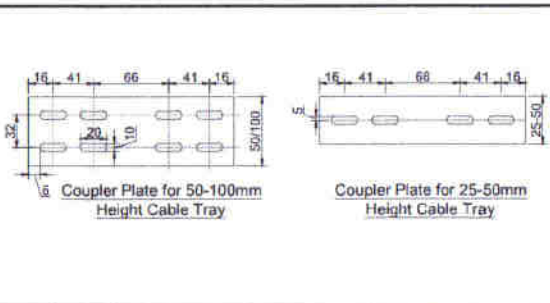

COVER FOR PERFORATED CABLE TRAY

COVER - K	TRAY	W	H	T
COVER - K	L.D.	50 TO 750	25 TO 50	1.6 TO 3.0

COVER - L	TRAY	W	H	T	C
COVER - L	H.D.	50 TO 800	50 TO 100	1.6 TO 3.0	15

COVER - M	TRAY	W	H2	T
COVER - M	L.D.	W+5	10 TO 25	1.6 TO 3.0

STANDARDS :-

MATERIAL :- MILD STEEL SHEET AS PER IS 1079 (SAIL, ESSAR, BHUSHAN/UTTAM, ISPAT)

FINISH :- HOT DIP GALVANISED AS PER IS : 2629 65 MICRON AVERAGE OR 460 GSM FOR NORMAL APPLICATIONS. 86 MICRON AVERAGE OF 610 GSM FOR CORROSIVE ENVIRONMENT.

ALTERNATIVE:- POWER COATED (4 COLORS CHOICE) BLUE, ORANGE, DA-GREY, SEIMENS-GREY

LENGTH :- 2500mm & 3000mm LONG

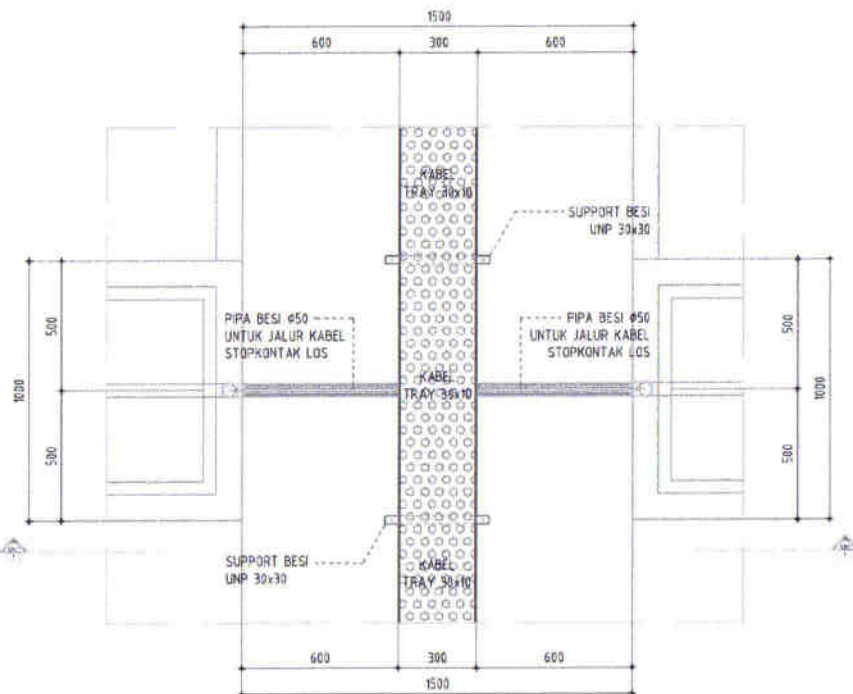

DETAIL KABEL TRAY
SKALA 1:20

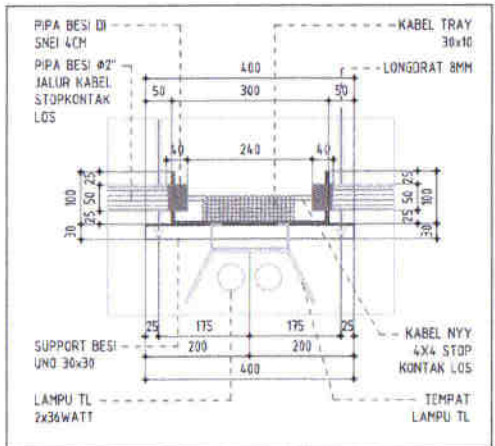

BLOW UP DETAIL A
SKALA 1:10

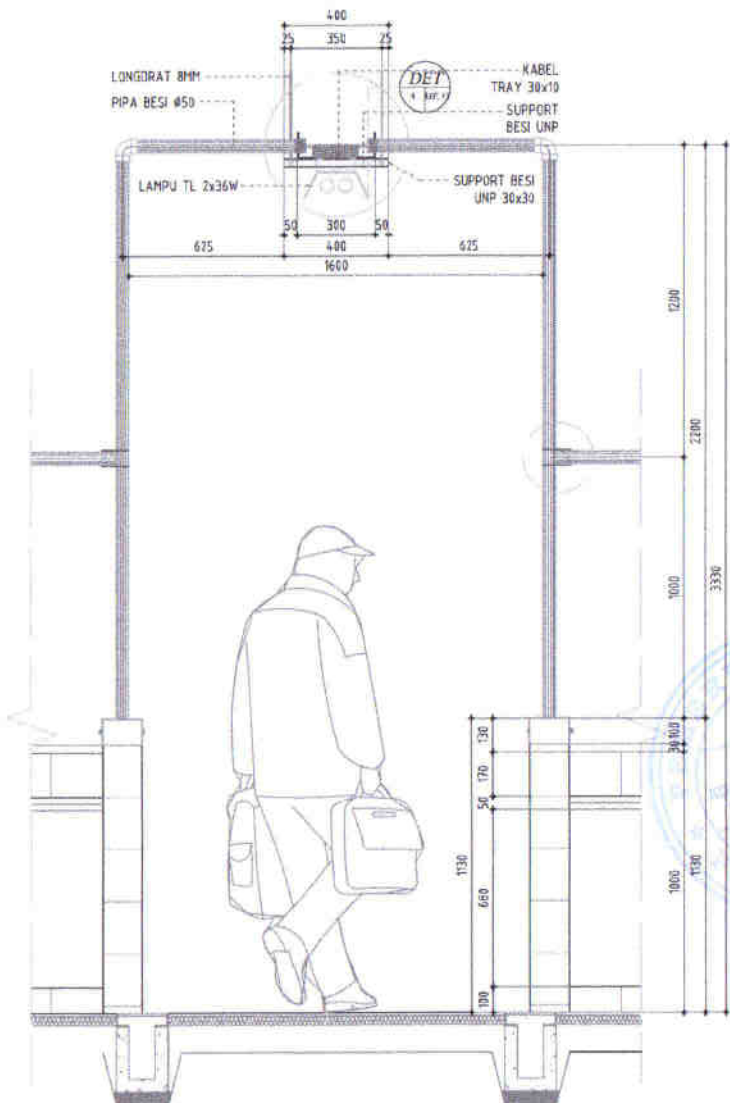

DETAIL POTONGAN 1
SKALA 1:20

KETERANGAN

Detail, Panel, Key Plan

NO	REVISI	PARAF		
		HI	RS	RS



Status	No. Gambar	No. Proyek
1:20		ME.12

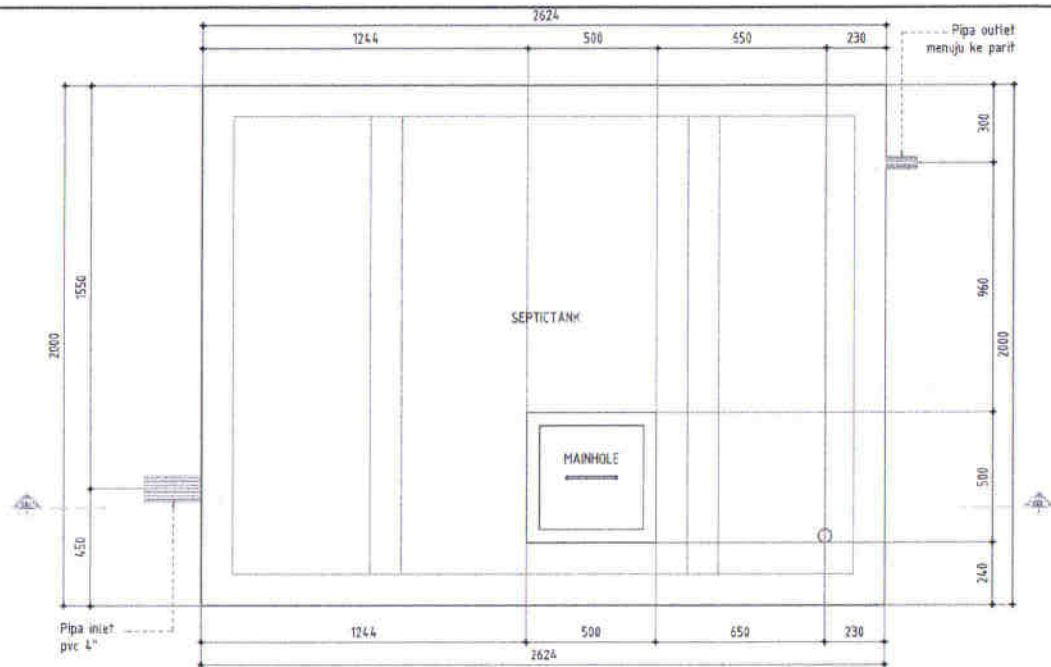

DENAH SEPTICTANK
SKALA 1:20

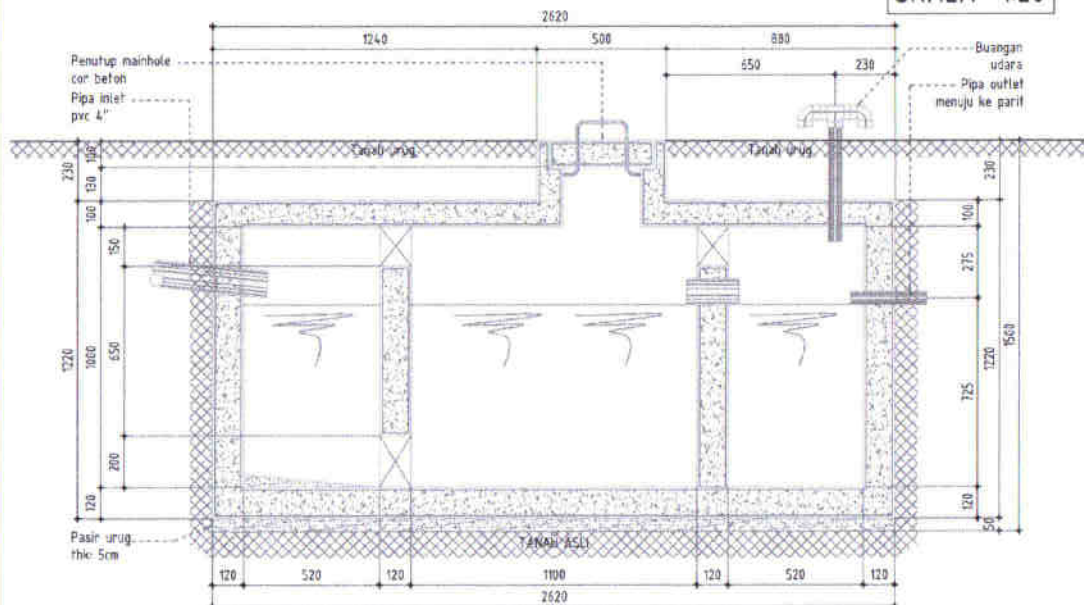

POTONGAN I-I
SKALA 1:20

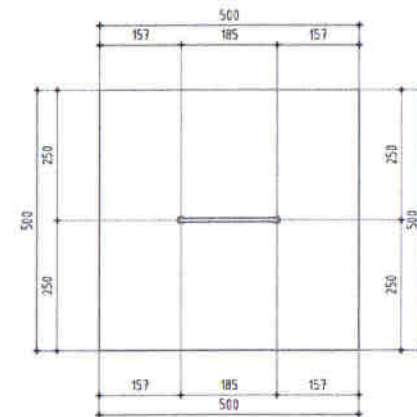

DETAIL PENUTUP MAINHOLE
SKALA 1:16

KETERANGAN

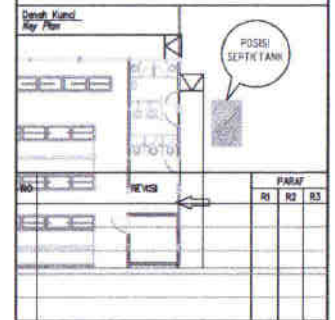

Colokan

Logo of **KEMENTERIAN PERDAGANGAN REPUBLIK INDONESIA** (Ministry of Trade, Republic of Indonesia).

Signature of **Manaridhal**, Kepala Dinas NERMAP, UPTD LAMBURO DOW PERDAGANGAN KOTA PORTOLANO.

Signature of **Manaridhal**, PLANNING MANAGER (KORPORASI).

Logo of **YARA PILAR KREASI, PT** (Engineering Consultant).

YEN TERIMA

ARBITER	LOUIS MAANDAM, CE, MT	
STRUKTUR	YANUARHARDI, ET	
MEK	BRUNYUJAH, ET	

Detail Project

Detail SEPTICTANK

Skala	No. Gambar	No. Dampak
1:20		PL 08

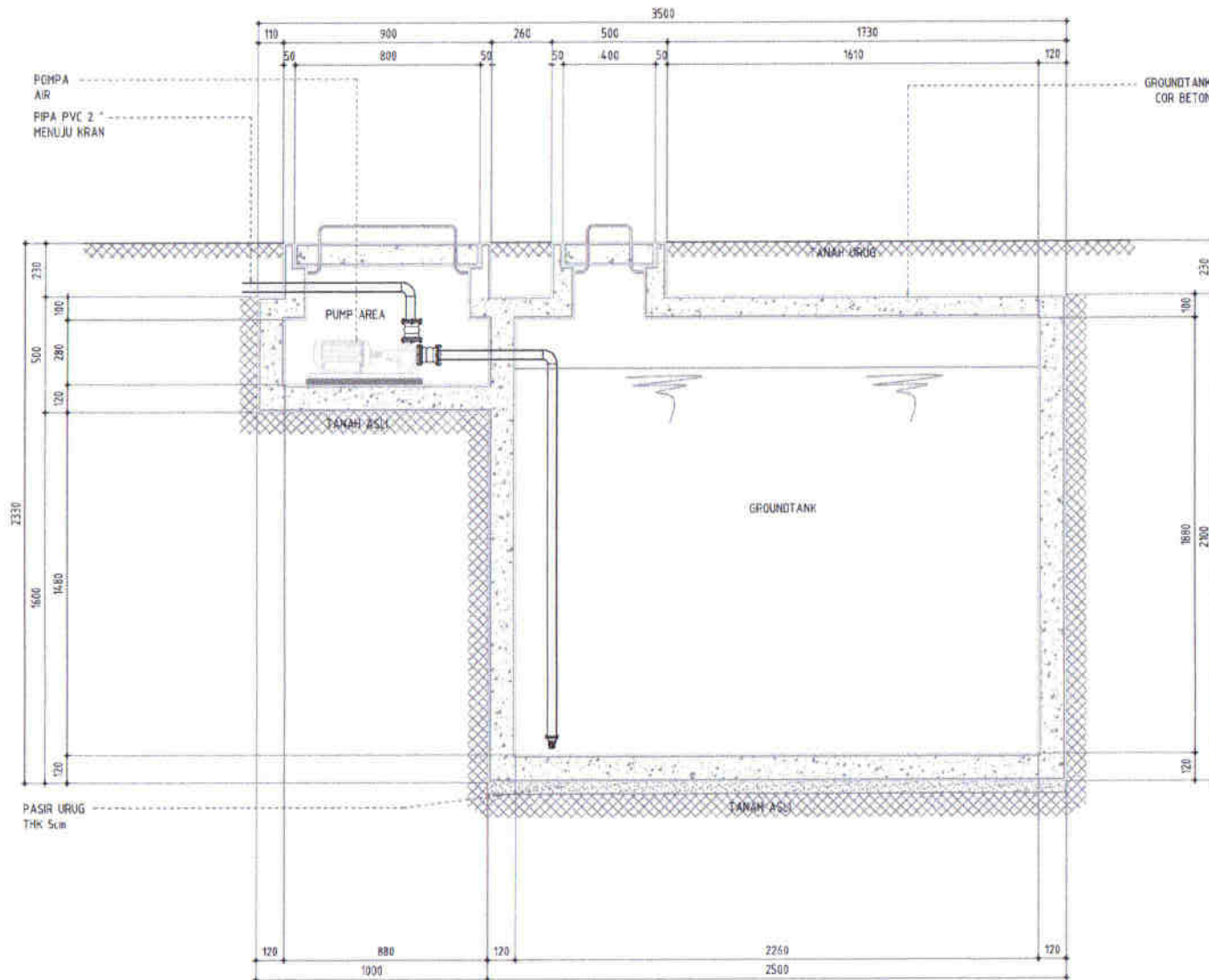

POTONGAN I-I
SKALA 1:20

KETERANGAN

Daerah, Koral, Key 7/20

NO	REVISI	PARAF		
		R1	R2	R3

Catatan

Dlm Client



Meresahkan

KEMENTERIAN PERDAGANGAN
REPUBLIC OF INDONESIA

KEPALA DINAS PERDAGANGAN
KOTA PONTIANAK

Meresahkan

PEJABAT KEMENTERIAN PERDAGANGAN

Scribble signature

JENJANG GAMBAR

TIARA PILAR KREASI, PT
Jl. ...

TEKNIK

DESIGNER: LOVELL KALYAN ST. ST.

STRUKTUR: ...

MK: ...

Drawn/Project

Jenis Gambar

POTONGAN GROUND TANK

Skala	No. Gambar	No. Prank
1:20		PL.10

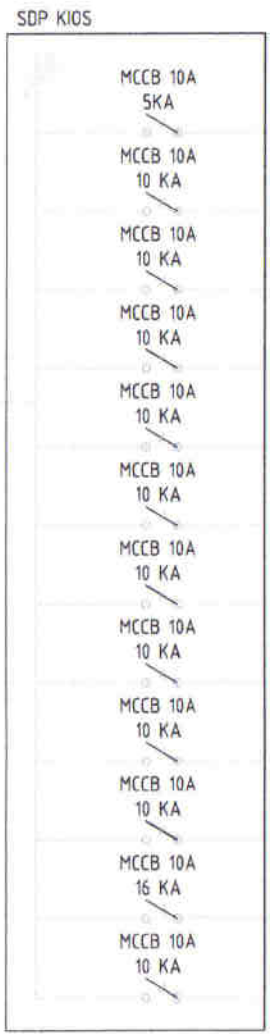
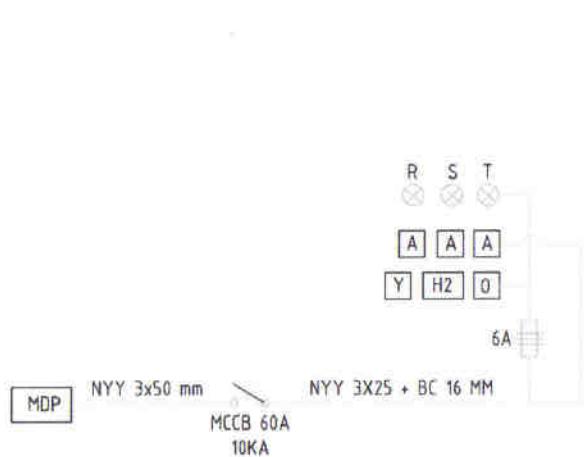

NY 3x4 mm	01	KIOS 1	900 WATT
NY 3x4 mm	02	KIOS 2 DAN 3	1800 WATT
NY 3x4 mm	03	KIOS 4 DAN 5	1800 WATT
NY 3x4 mm	04	KIOS 6 DAN 7	1800 WATT
NY 3x4 mm	05	KIOS 8 DAN 9	1800 WATT
NY 3x4 mm	06	KIOS 10 DAN 11	1800 WATT
NY 3x4 mm	04	KIOS 12 DAN 13	1800 WATT
NY 3x4 mm	07	KIOS 14 DAN 15	1800 WATT
NY 3x4 mm	08	KIOS 16 DAN 17	1800 WATT
NY 3x4 mm	09	KIOS 18 DAN 19	1800 WATT
NY 3x4 mm	10	RUANG ATM 20-22	6600 WATT
NY 3x4 mm	11	CADANGAN 23-25	

KETERANGAN

Detail Item
Key Plan

NO	REVISI	PARAF		
		R1	R2	R3

Colokan



Manajemen
KEPAK & BINA KOPERASI, USAHA MINGGU DAN PERCAGALAN
KOTA PONTIANAK

Manajemen
PEJABAT PEMBINAAN KOPERASI (PKOP)

KONSULTAN GAMBAR
TIARA PILAR KREASI, PT
Manajemen & Desain yang Terpadu

TEN TEKNIK
LOKASI: LUTUH VALL NEHRE 17, RT
STRUKTUR: MAHARAJA KEL. 17
NO: 17/04/2024, RT

Nama Gambar
WIRING DIAGRAM SDP KIOS



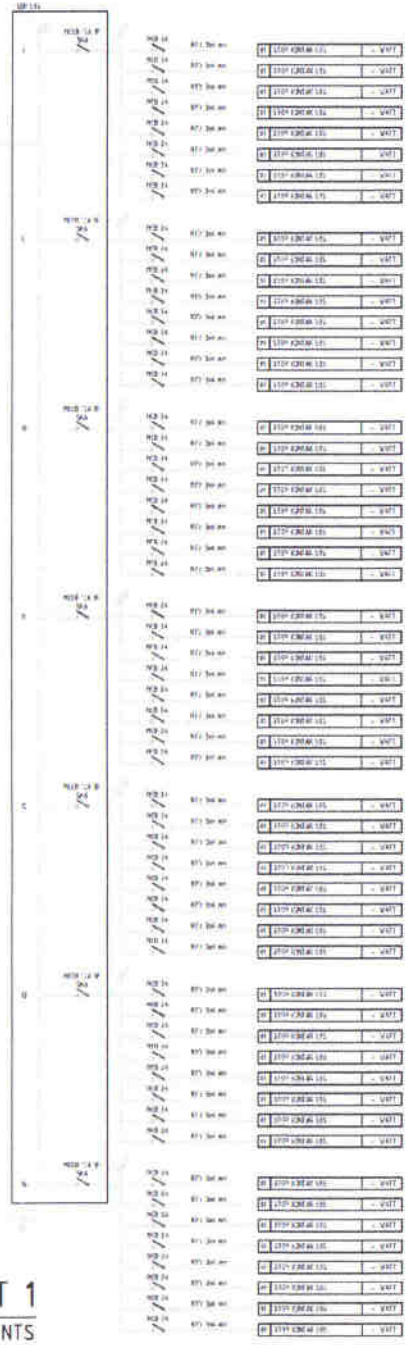
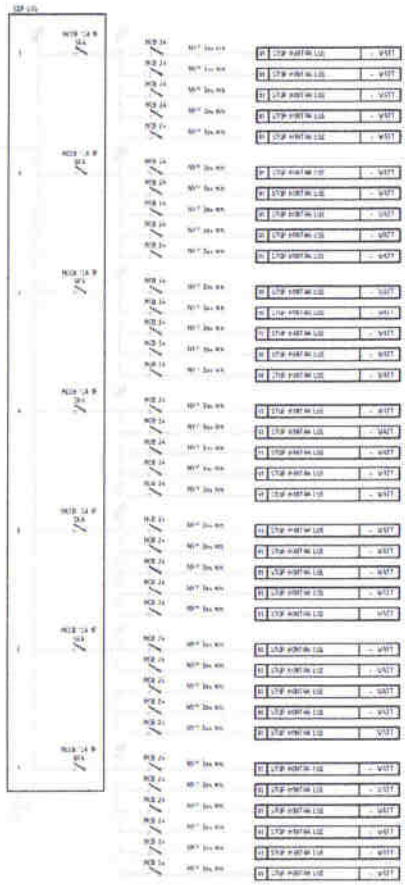
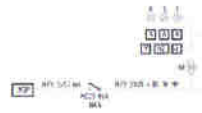

Skala	No. Gambar	No. Proposal
NTS		ME.08

WIRING DIAGRAM SDP KIOS
SKALA NTS



WIRING DIAGRAM SDP LOS PART 1
SKALA NTS

KETERANGAN

Draft Hand Key Plan			
NO	REVISI	PARAF	
		RI	R3
Catatan			
 REPUBLIC OF INDONESIA DEPARTMENT OF TRADE			
Mengetahui Kepala Dinas Perdagangan, Logistik dan Perindustrian Kota Pekanbaru  Kepala Dinas Perdagangan, Logistik dan Perindustrian Kota Pekanbaru			
Mengetahui Kepala Bidang Logistik dan Perindustrian  Kepala Bidang Logistik dan Perindustrian			
HONSIJAH SANGRI  TIARA PILAR KREANI, PT Management & Engineering Consultant Jl. Sialang Baru, No. 10, Pekanbaru, Riau 28112			
TIN TERANG WITON LOUZI SULANDARI, ST, MT STRUKTUR WAMBIKOFAC, ST NEE WENHAI, ST			
Proyek / Project WIRING DIAGRAM SDP LOS PART 1 J.P.C. - Pekanbaru			
Nama Gambar WIRING DIAGRAM SDP LOS PART 1			
Skala	No. Gambar	No. Proyek	
NTS		ME.06	

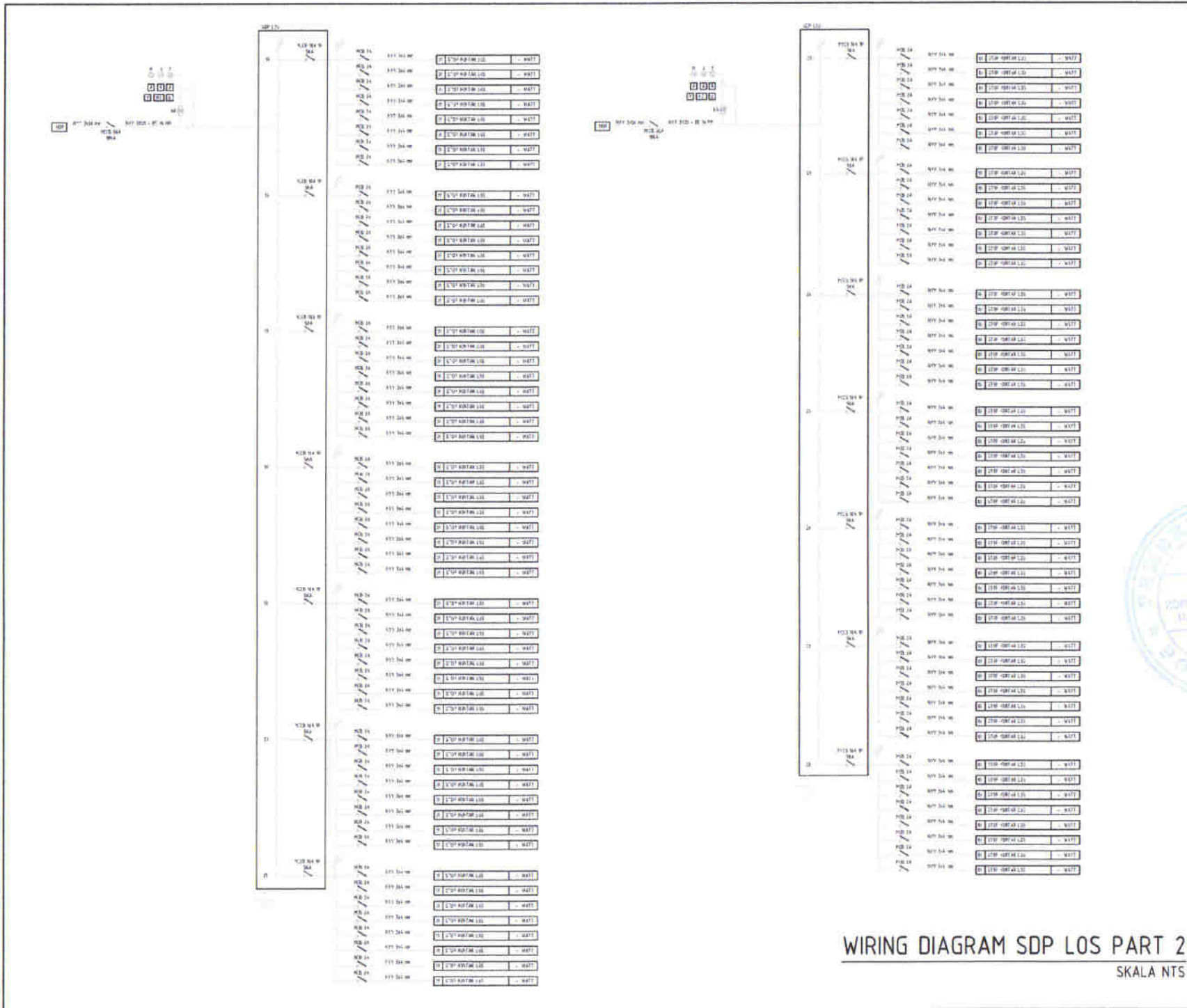

KETERANGAN			
Denah Koneksi Key Plan			
NO	REVISI	PARAF	
		RI	RO
Catatan			
Klien  MINISTRY OF TRANSPORTATION Jl. Medan Merdeka Selatan No. 1, Jakarta Pusat, 10119 Indonesia			
Manajer HENRIKA DEWI SUPRIATNA, MSc, MEng, MSc, PhD, PERENCANA ACEA & ASSOCIATES 			
Manajer YUSUF HANIKAH, MSc, MEng, MSc, PhD, PERENCANA 			
KONSTRUKSI GAMBAR  TIARA PILAR KREASI, PT <small>Perencanaan & Konstruksi Teknik Sipil</small>			
SWK TERBUKA ANSITIK LORENS WILANDARI, ST, MT ESTASITON HARVARD PRATIWI MEE BIRAHU DAHM, ST			
Proyek Project WIRING DIAGRAM SDP LOS PART 2			
Nama Gambar WIRING DIAGRAM SDP LOS PART 2			
Skala	No. Gambar	No. Proyek	
NTS		ME.01	

WIRING DIAGRAM SDP LOS PART 2
SKALA NTS

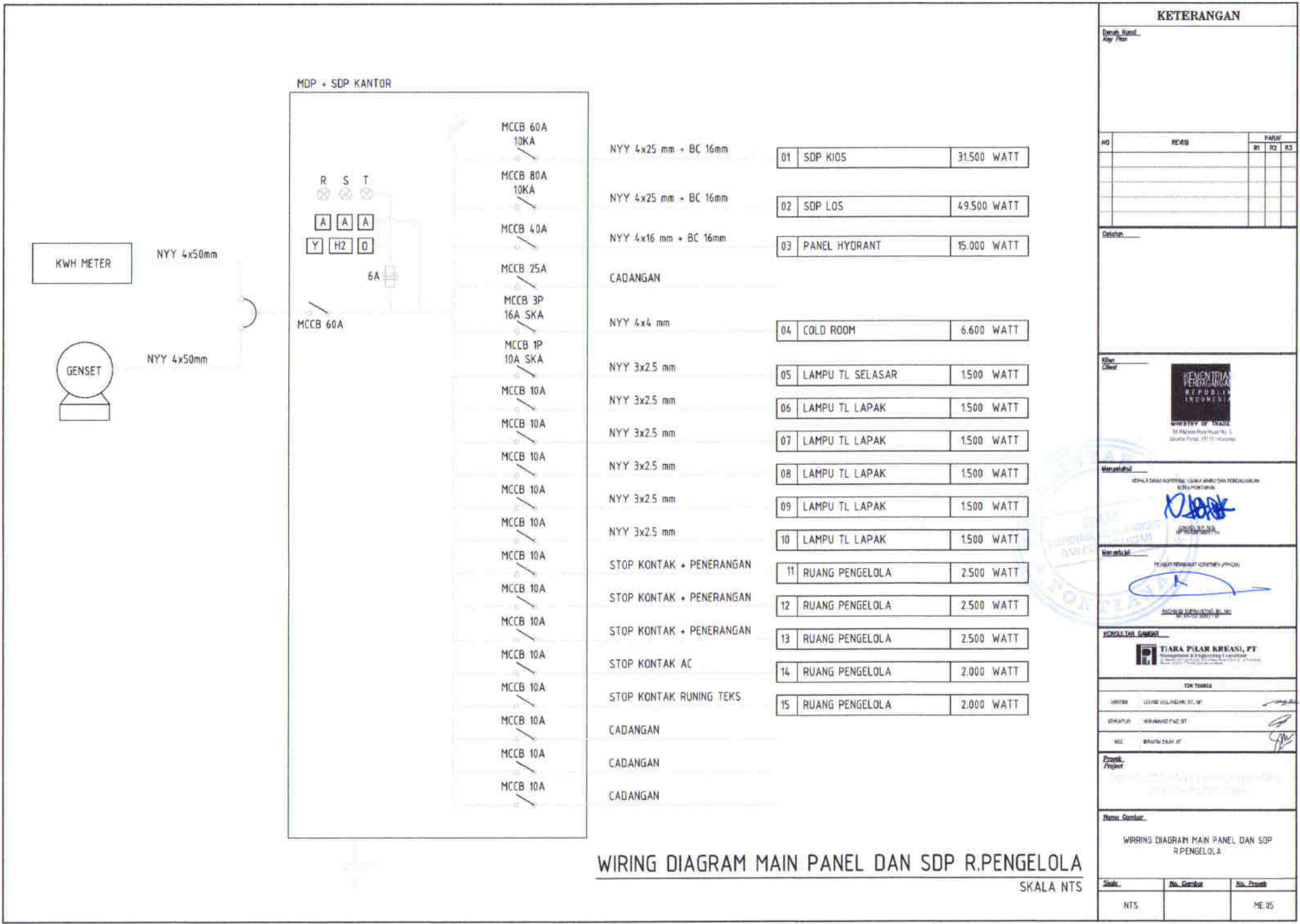

KETERANGAN				
Detail Item, Any Item				
NO	REVISI	PARALEL		
		R1	R2	R3
Catatan				
				
<p>Mengetahui</p> <p>KEPALA DINAS KEPERAWATAN UMUM DAN PERENCANAAN BINA POKJAN</p> <p><i>[Signature]</i></p>				
<p>Mengetahui</p> <p>PEKERTY PERENCANAAN (KEMENKES)</p> <p><i>[Signature]</i></p>				
<p>KONSULTAN GIMBAR</p> <p>TIARA PILAR KREASI, PT</p> <p>Indonesian & International Engineering Consultant</p> <p>YOKYAKARTA</p>				
<p>ORDER: LUISA VALLINOTTO, ST, MT</p> <p>REVISI: MURAHAD FAD ST</p> <p>REVISI: BRUNO DAHM ST</p>				
<p>Project/Project</p> <p>WIRING DIAGRAM MAIN PANEL DAN SDP R.PENGELOLA</p>				
<p>Rev. Gambar</p> <p>WIRING DIAGRAM MAIN PANEL DAN SDP R.PENGELOLA</p>				
Skala	No. Gambar	No. Proyek		
NTS		ME.05		

WIRING DIAGRAM MAIN PANEL DAN SDP R.PENGELOLA
SKALA NTS

BV 2

BV 3

KETERANGAN

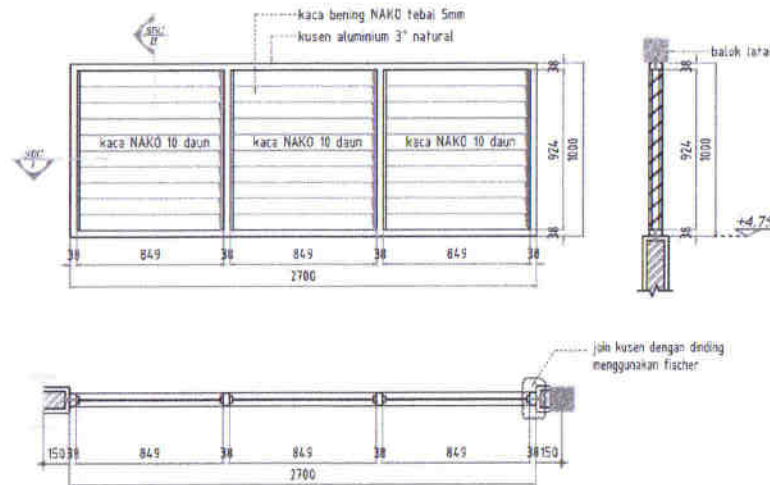
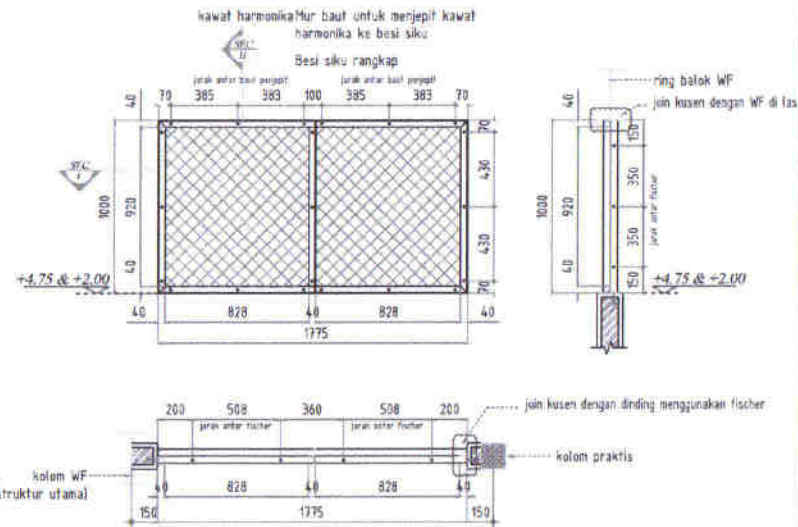

Detail, Isod., Key Plan

NO	REVISI	PARAF		
		RT	R2	R3

Colokan



Mengetahui
KEPTUKAN PERUSAHAAN, LEMBAGA PERSEKUTUAN PERUSAHAAN
KOTA PORTOLARA
[Signature]
KEPTUKAN PERUSAHAAN

Mengetahui
PELAKSANA PEMBUATAN KONTAK PERUSAHAAN
[Signature]
KONTAK PERUSAHAAN

HONGGAZAH GEMAY
TIARA PILAR KREASI, PT
Manajemen & Pengembangan Perumahan
Jl. ...

ESN TERBUK
ARTIST: LOURELLA ANDRIAN, RT, MT

STRUKTUR: WURUMBAGAL RT
KIT: BAHAYU SARI RT

Project
Project

Nama Gambar
DETAIL BV2 & BV3

Skala	No. Gambar	No. Proyek
1:30		A 18

LOKASI	LIHAT DENAH KUNCI KUSEN
JUMLAH	2 BUAH
MATERIAL	BESI SIKU DAN KAWAT HARMONIKA
KACA	-
ASESORIS	-
TIPE KUNCI	-
ENGSEL	-
FINISHING	CAT DUCO WARNA HITAM DOFF

LOKASI	LIHAT DENAH KUNCI KUSEN
JUMLAH	5 BUAH
MATERIAL	KUSEN ALUMINIUM 3" NATURAL
KACA	KACA NAKO
ASESORIS	-
TIPE KUNCI	-
ENGSEL	ENGSEL NAKO
FINISHING	NATURAL

FG 1

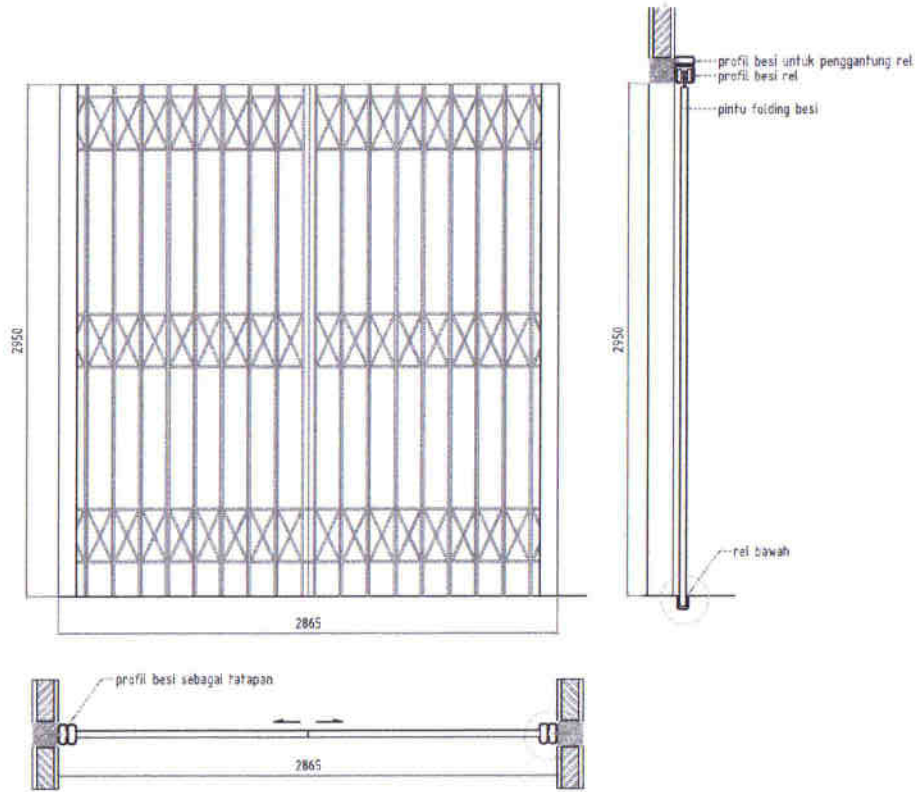

LOKASI	PINTU UTAMA DEPAN DAN BELAKANG
JUMLAH	2 BUAH
MATERIAL	PINTU HARMONIKA
KACA	-
ASESORIS	-
TIPE KUNCI	BY PRODUCT
ENGSEL	BY PRODUCT
FINISHING	CAT DUCO WARNA HITAM DOFF

FG 2

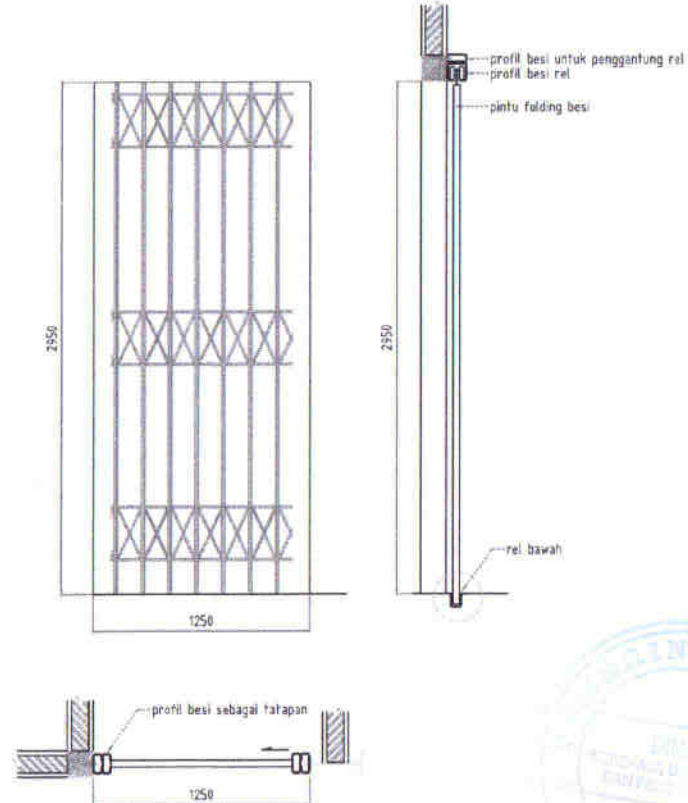

LOKASI	PINTU UTAMA SAMPING KANAN KIRI
JUMLAH	2 BUAH
MATERIAL	PINTU HARMONIKA
KACA	-
ASESORIS	-
TIPE KUNCI	BY PRODUCT
ENGSEL	BY PRODUCT
FINISHING	CAT DUCO WARNA HITAM DOFF

KETERANGAN

Daerah Hasil
Key Plan

NO	REVISI	PARAF		
		MT	RS	RT

Customer



Marsudi
KEMENTERIAN PERDAGANGAN REPUBLIK INDONESIA
KEMENTERIAN PERDAGANGAN REPUBLIK INDONESIA
KEMENTERIAN PERDAGANGAN REPUBLIK INDONESIA

Marsudi
PELAKSANAAN KEMENTERIAN PERDAGANGAN REPUBLIK INDONESIA
PELAKSANAAN KEMENTERIAN PERDAGANGAN REPUBLIK INDONESIA

KONSULTAN GAMBAR
TIARA PILAR KREASI, PT
Management & Engineering Consultant
KONSULTAN GAMBAR

YON YENNY
WRITER: LOUISA VALERIE, ST., MT
STRUKTUR: HENRIANDY AGUS
MSE: IRWAN ZULH, ST

Proyek
Project

Nama Gambar
DETAIL FG1 & FG2

Skala	No. Gambar	No. Prosk
1:20		A 22

PJ 2

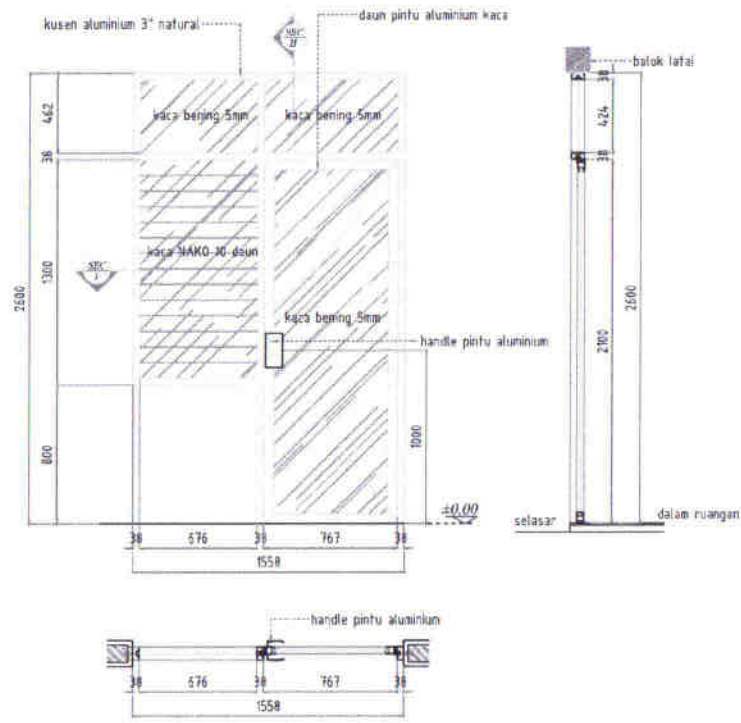

PT 1

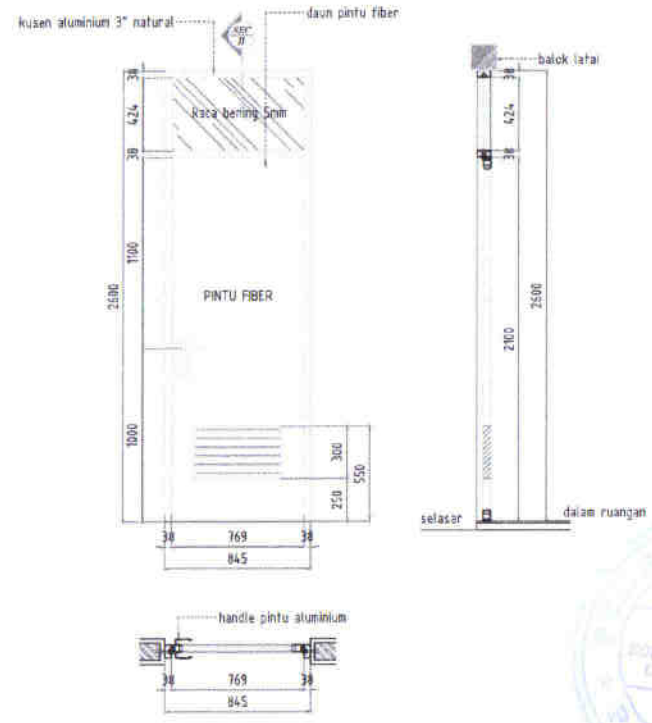

KETERANGAN

Denah Kunci Key Plan

NO	REVISI	PARAF		
		R1	R2	R3

Catatan



Membantu
KEPALA DINAS PERUSAHAAN UMUM BANGUNAN PERKOTAAN DAN KOTA PORTABER
Jember, 15 Mei 2024

Membantu
PLIBIG PERUSAHAAN KEMENTERIAN PERUSAHAAN
Jember, 15 Mei 2024

Membantu Gambar
TIARA PILAR KREANI, PT
Membantu Gambar & Dokumentasi Teknik
Jember, 15 Mei 2024

CONTOH
ANGKET: LOKASI (SALINAN) AT. 01
SPRINTER: MURNING FAL ST
REVISI: MURNING FAL ST

Detail Project
Detail PJ 2 & PT 1

Nama Gambar
DETAIL PJ 2 & PT 1

Skala	No. Gambar	No. Proses
1:30.0001		A 20

LOKASI	LIHAT DENAH KUNCI KUSEN
JUMLAH	3 BUAH
MATERIAL	KUSEN ALUMINIUM 3" NATURAL
KACA	KACA NAKO DAN KACA BENING 5MM
ASESORIS	HANDLE PROFIL ALUMINIUM
TIPE KUNCI	KUNCI TANAM
ENGSEL	ENGSEL KUPU, ENGSEL NAKO
FINISHING	NATURAL

LOKASI	LIHAT DENAH KUNCI KUSEN
JUMLAH	2 BUAH
MATERIAL	KUSEN ALUMINIUM 3" NATURAL
KACA	KACA BENING 5MM
ASESORIS	HANDLE STANDART, GRILL PVC
TIPE KUNCI	KUNCI TANAM
ENGSEL	ENGSEL KUPU
FINISHING	NATURAL

RD 1

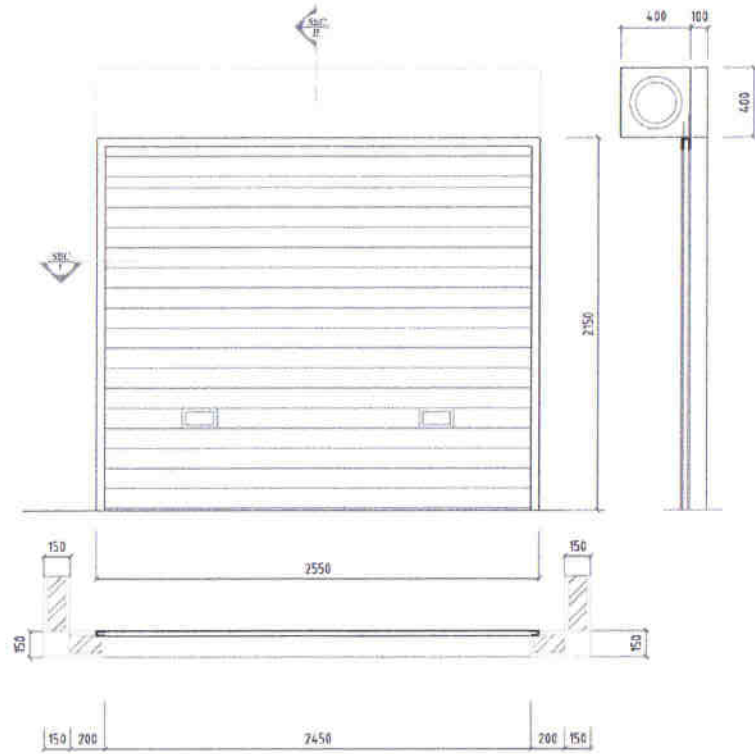

RD 2

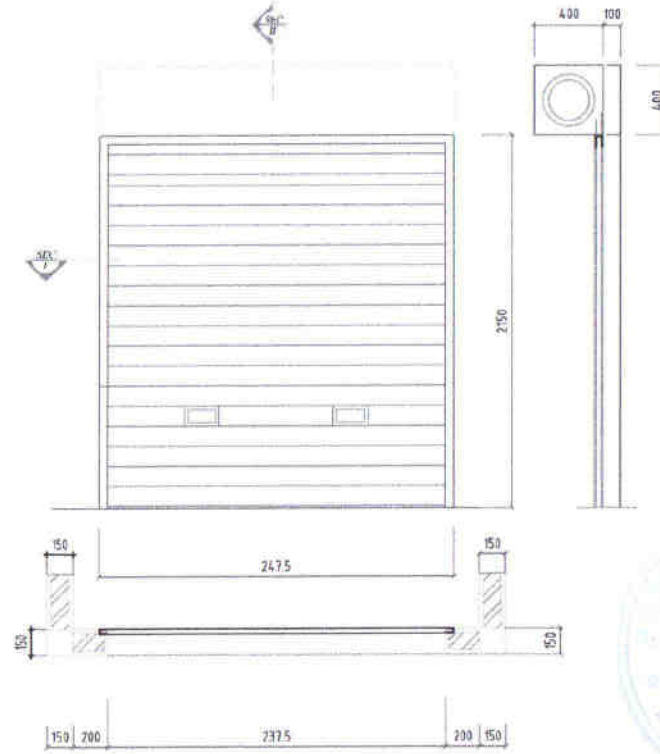

KETERANGAN

Detail, Detail, Rev. Plan

NO	REVISI	PARAF		
		R1	R2	R3

Klien



KEMENTERIAN PERDAGANGAN
REPUBLIK INDONESIA
MINISTRY OF TRADE
Jl. Sisinga Raya No. 1
Jakarta Pusat 10110 Indonesia

Materi 1

DEPT. TEKNIK SIPIL DAN PERENCANAAN
KATA PENGANTAR

[Signature]
DIREKTOR

Materi 2

PERBATAS PERENCANAAN SIPIL

[Signature]
DIREKTOR

MONSIEUR GAMBUT

TIARA PIJAL BREANI, PT
Perencana & Engineering Consultant
Jl. ...

CON TRUCKS

AWITER: COLISE VILANAR, ET. AF

STAMBUK: ...

MS: ...

Project

Nama Gambar

DETAIL ROLLING DOOR 1&2

Skala	No. Gambar	No. Proses
1:30		A.16

LOKASI	KIOS (1-7) , (12-24) & (29-35)
JUMLAH	28 BUAH
MATERIAL	ROLLING DOOR ALUMINIUM
KACA	-
ASESORIS	BOX ROLLING
TIPE KUNCI	KUNCI TANAM
ENGSEL	ROLL BY PRODUCT
FINISHING	NATURAL BY PRODUCT

LOKASI	KIOS (8-11) & (25-28)
JUMLAH	8 BUAH
MATERIAL	ROLLING DOOR ALUMINIUM
KACA	-
ASESORIS	BOX ROLLING
	KUNCI TANAM
ENGSEL	ROLL BY PRODUCT
FINISHING	NATURAL BY PRODUCT

RD 3

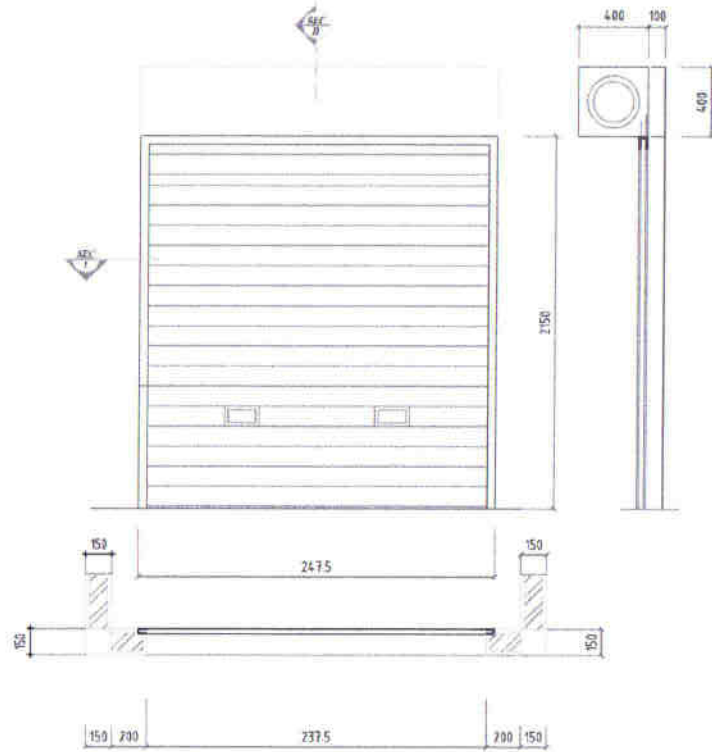

LOKASI	KIOS (8-11) & (25-28)
JUMLAH	4 BUAH
MATERIAL	ROLLING DOOR ALUMINIUM
KACA	-
ASESORIS	BOX ROLLING
TIPE KUNCI	KUNCI TANAM
ENGSEL	ROLL BY PRODUCT
FINISHING	NATURAL BY PRODUCT

BV 1

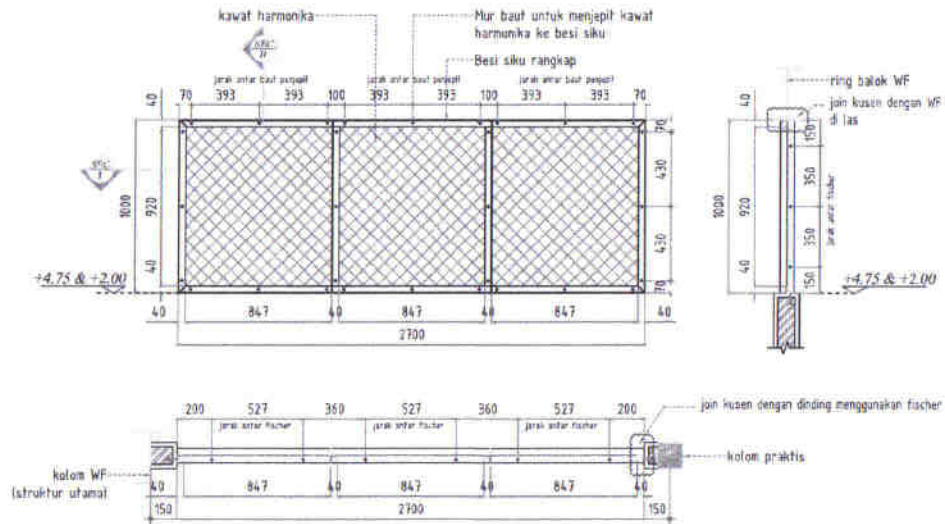

LOKASI	UNTUK AREA YANG TERLINDUNGI ATAP (LIHAT DENAH KUNCI KUSEN)
JUMLAH	48 BUAH
MATERIAL	BESI SIKU DAN KAWAT HARMONIKA
KACA	-
ASESORIS	-
TIPE KUNCI	-
ENGSEL	-
FINISHING	CAT DUCO WARNA HITAM DOFF

KETERANGAN

Denah Kunci
Ary Pan

NO	REVISI	PARAF		
		R1	R2	R3

Contoh



Memorandum
GIBLA DWIS PERVAL, USAHA BANGUNAN PERKAWANING
OF A PORTUGAL

Memorandum
PLUMBING PERALANG - KONTAK (P/01)

KONSULTAN GMBH
TARA PIAR KREASI, PT
Throughtech & Engineering Consultant

TSN THORNT
ARBITR LOUIS ELLIANDER, RI, AT
STRUKTUR MAMMADOE, BT
REE BRANW DAN, RT

Project
MELUKA BANGUNAN KAWANING PERKAWANING
STRUKTUR PERALANG

Nama Gambar
DETAIL ROLLING DOOR 3 & BV1

Skala	No. Gambar	No. Proyek
1:30		A.17

J 1		P 1		P B		KETERANGAN																														
						<p>Denah, Elevasi, Key Plan</p> <table border="1"> <thead> <tr> <th rowspan="2">NO</th> <th rowspan="2">REVISI</th> <th colspan="3">PARAF</th> </tr> <tr> <th>R1</th> <th>R2</th> <th>R3</th> </tr> </thead> <tbody> <tr><td> </td><td> </td><td> </td><td> </td><td> </td></tr> <tr><td> </td><td> </td><td> </td><td> </td><td> </td></tr> <tr><td> </td><td> </td><td> </td><td> </td><td> </td></tr> <tr><td> </td><td> </td><td> </td><td> </td><td> </td></tr> </tbody> </table> <p>Catatan</p> <p>Client: </p> <p>Manajemen: </p> <p>Manufaktur: </p>			NO	REVISI	PARAF			R1	R2	R3																				
NO	REVISI	PARAF																																		
		R1	R2	R3																																
LOKASI	LIHAT DENAH KUNCI KUSEN	LOKASI	LIHAT DENAH KUNCI KUSEN	LOKASI	R. PENYIMPANAN DAGING	<p>MANUFAKTUR GEMBAR</p> <p></p> <p>FOR TERMS</p> <p>AWTER: LUCAS SALLIMAN (R.1)</p> <p>STRUKTUR: MAHARANI EST</p> <p>KE: BUNYI TAJUK (R)</p>																														
JUMLAH	2 BUAH	JUMLAH	1 BUAH	JUMLAH	1 BUAH	<p>Project: </p>																														
MATERIAL	KUSEN ALUMINIUM 3" NATURAL	MATERIAL	KUSEN ALUMINIUM 3" NATURAL	MATERIAL	KUSEN BESI HOLLOW 2"	<p>Nama Gambar: DETAIL J1 & P1 & PB</p>																														
KACA	KACA NAKO DAN KACA BENING 5mm	KACA	KACA BENING 5mm	KACA	PLAT BESI 2mm RANGKA BESI HOLLOW 3CM	<p>Status: 1:30</p> <p>No. Gambar: A.21</p>																														
ASESORIS	-	ASESORIS	HANDLE PROFIL ALUMINIUM	ASESORIS	HANDLE BESI BETON Ø16mm																															
TIPE KUNCI	-	TIPE KUNCI	KUNCI TANAM	TIPE KUNCI	PLAT GRENDREL																															
ENGSEL	ENGSEL NAKO	ENGSEL	ENGSEL KUPU	ENGSEL	ENGSEL BUBUT 12mm JUMLAH 3 bh																															
FINISHING	NATURAL	FINISHING	NATURAL	FINISHING	CAT DUCO WARNA HITAM DOFF																															

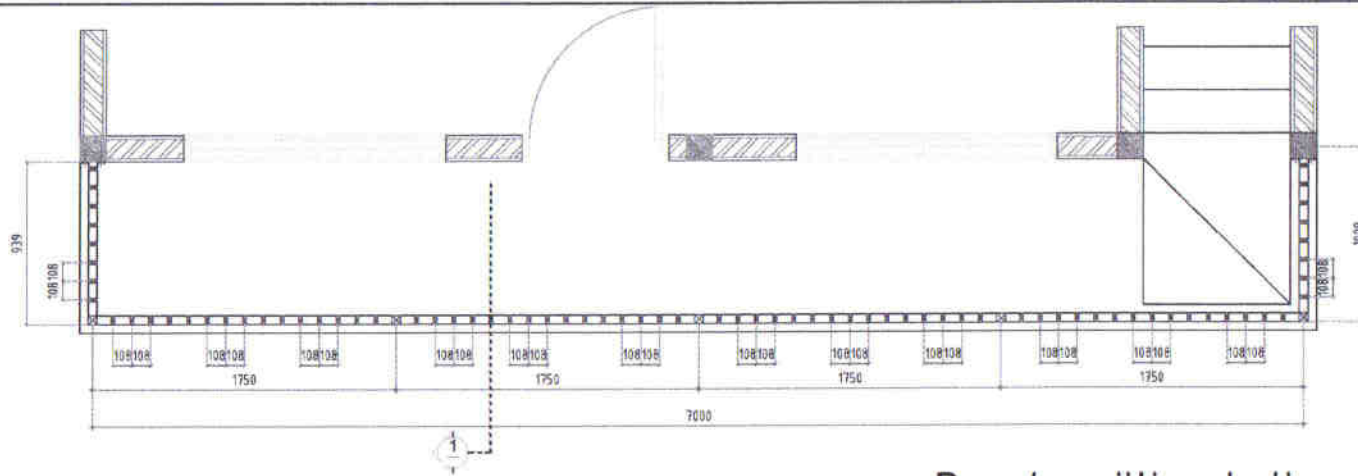

Denah railing balkon

SKALA 1:30

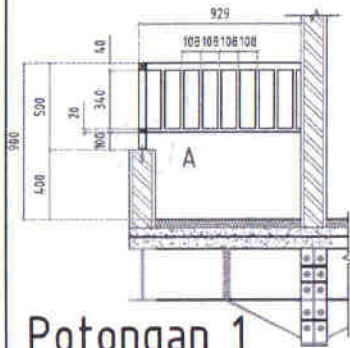

Potongan 1

SKALA 1:30

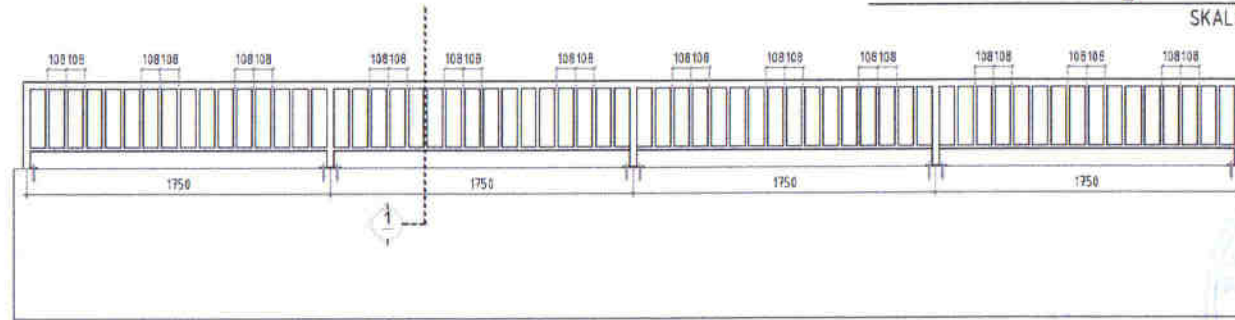

Tampak depan railing balkon

SKALA 1:30

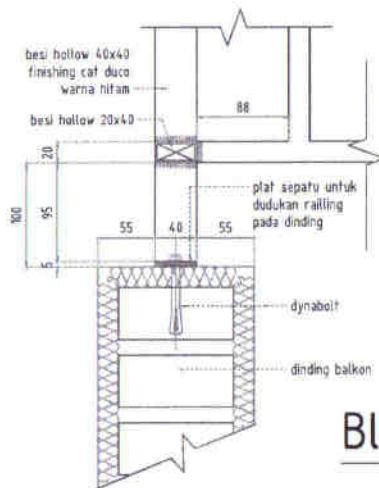

Blow up A

SKALA 1:5

KETERANGAN

Detail Hand.
Key Plan

NO	REVISI	PARAM		
		R1	R2	R3

Catatan

Client

KEMENTERIAN PERDAGANGAN
REPUBLIC OF INDONESIA
MINISTRY OF TRADE
Jl. Pahlawan Revolusi No. 1
Jakarta Pusat 10110 Indonesia

Manajemen

KEPLA DINAS KOPERASI, USAHA KURUS DAN PERKUSIS BINA
KOTA KOTA KAYU

Manajemen

PLUJAT KEMAHOTELAN KOTAMENINGGAH

KONSULTAN GAMBAR

TARA PILAR KREASI, PT
Management & Engineering Firm

DESAIN

NO. 1001
LOKASI: PLANDANG, RI, ID

STRUKTUR: SANHARAFINE, IT

MEK: BIRUHAZAH, IT

Detail
Project

MANAGEMENT & ENGINEERING FIRM
Jl. Pahlawan Revolusi No. 1
Jakarta Pusat 10110 Indonesia

Detail Gambar

DETAIL RAILING BALKON

Scale	No. Gambar	No. Detail
1:30 & 1:5		A.41

